



# USB On-the-Go Transceiver and Charge Pump

MAX3301E

## General Description

The MAX3301E fully integrated USB On-the-Go (OTG) transceiver and charge pump allows mobile devices such as PDAs, cellular phones, and digital cameras to interface directly with USB peripherals and each other without the need of a host PC. Use the MAX3301E with an embedded USB host to directly connect to peripherals such as printers or external hard drives.

The MAX3301E integrates a USB OTG transceiver, a VBUS charge pump, a linear regulator, and an I<sup>2</sup>C™-compatible, 2-wire serial interface. An internal level shifter allows the MAX3301E to interface with logic supply voltages from +1.65V to +3.6V. The MAX3301E's OTG-compliant charge pump operates with +3V to +4.5V input supply voltages, and supplies an OTG-compatible output on VBUS while sourcing more than 8mA of output current.

The MAX3301E enables USB OTG communication from highly integrated digital devices that cannot supply or tolerate the +5V VBUS levels that USB OTG requires. The device supports USB OTG session-request protocol (SRP) and host-negotiation protocol (HNP) by controlling and measuring VBUS using internal comparators.

The MAX3301E provides built-in ±15kV electrostatic-discharge (ESD) protection for the VBUS, ID\_IN, D+, and D- terminals. The MAX3301E is available in 5 x 5 chip-scale (UCSP™) and 32-pin (5mm x 5mm x 0.8mm) thin QFN packages and operates over the extended -40°C to +85°C temperature range.

## Applications

Mobile Phones  
PDAs  
Digital Cameras  
MP3 Players  
Photo Printers

*I<sup>2</sup>C is a trademark of Philips Corp.*

*Purchase of I<sup>2</sup>C components from Maxim Integrated Products, Inc. or one of its sublicensed Associated Companies, conveys a license under the Philips I<sup>2</sup>C Patent Rights to use these components in an I<sup>2</sup>C system, provided that the system conforms to the I<sup>2</sup>C Standard Specification as defined by Philips.*

*UCSP is a trademark of Maxim Integrated Products, Inc.*

## Features

- ◆ **USB 2.0-Compliant Full-/Low-Speed OTG Transceivers**
- ◆ **Ideal for USB On-the-Go, Embedded Host, or Peripheral Devices**
- ◆ **±15kV ESD Protection on ID\_IN, VBUS, D+, and D-Terminals**
- ◆ **Charge Pumps for VBUS Signaling and Operation Down to 3V**
- ◆ **Internal VBUS and ID Comparators**
- ◆ **Internal Switchable Pullup and Pulldown Resistors for Host/Peripheral Functionality**
- ◆ **I<sup>2</sup>C Bus Interface with Command and Status Registers**
- ◆ **Linear Regulator Powers Internal Circuitry and D+/D- Pullup Resistors**
- ◆ **Supports Car Kit Interrupts and Audio-Mode Operation**
- ◆ **Supports SRP and HNP**
- ◆ **Low-Power Shutdown Mode**
- ◆ **Available in 32-Pin Thin QFN and 5 x 5 UCSP Packages**

## Ordering Information

PART	TEMP RANGE	PIN-PACKAGE	PKG. CODE
MAX3301EETJ	-40°C to +85°C	32 Thin QFN-EP*	T3255-4
MAX3301EEBA-T	-40°C to +85°C	5 x 5 UCSP	B25-1

\*EP = Exposed paddle.

\*\*Requires solder temperature profile described in the Absolute Maximum Ratings section. UCSP reliability is integrally linked to the user's assembly methods, circuit board material, and environment. See the UCSP Reliability Notice in the UCSP Applications Information section of this data sheet for more information.

*Typical Operating Circuit and Pin Configurations appear at end of data sheet.*



# USB On-the-Go Transceiver and Charge Pump

MAX3301E

## ABSOLUTE MAXIMUM RATINGS

All voltages are referenced to GND.

V <sub>CC</sub> , V <sub>L</sub> .....	-0.3V to +6V
TRM (regulator off or supplied by V <sub>BUS</sub> ) ..-	-0.3V to (V <sub>BUS</sub> + 0.3V)
TRM (regulator supplied by V <sub>CC</sub> ) .....	-0.3V to (V <sub>CC</sub> + 0.3V)
D+, D- (transmitter tri-stated) .....	-0.3V to +6V
D+, D- (transmitter functional) .....	-0.3V to (V <sub>CC</sub> + 0.3V)
V <sub>BUS</sub> .....	-0.3V to +6V
ID_IN, SCL, SDA .....	-0.3V to +6V
INT, SPD, RESET, ADD, OE/INT, RCV, VP, VM, SUS, DAT_VP, SE0_VM .....	-0.3V to (V <sub>L</sub> + 0.3V)
C+ .....	-0.3V to (V <sub>BUS</sub> + 0.3V)
C- .....	-0.3V to (V <sub>CC</sub> + 0.3V)
Short-Circuit Duration, V <sub>BUS</sub> to GND .....	Continuous

Continuous Power Dissipation (T <sub>A</sub> = +70°C)	
5 x 5 UCSP (derate 12.2mW/°C above +70°C) .....	976mW
32-Pin Thin QFN (5mm x 5mm x 0.8mm) (derate 21.3mW/°C above +70°C) .....	1702mW
Operating Temperature Range .....	-40°C to +85°C
Junction Temperature .....	+150°C
Storage Temperature Range .....	-65°C to +150°C
Lead Temperature (soldering, 10s) .....	+300°C
Bump Reflow Temperature (Note 1)	
Infrared (15s) .....	+200°C
Vapor Phase (20s) .....	+215°C

**Note 1:** The UCSP package is constructed using a unique set of packaging techniques that impose a limit on the thermal profile the device can be exposed to during board-level solder attach and rework. This limit permits only the use of the solder profiles recommended in the industry-standard specification, JEDEC 020A, paragraph 7.6, Table 3 for IR/VPR and convection reflow. Preheating is required. Hand or wave soldering is not allowed.

Stresses beyond those listed under "Absolute Maximum Ratings" may cause permanent damage to the device. These are stress ratings only, and functional operation of the device at these or any other conditions beyond those indicated in the operational sections of the specifications is not implied. Exposure to absolute maximum rating conditions for extended periods may affect device reliability.

## DC ELECTRICAL CHARACTERISTICS

(V<sub>CC</sub> = +3V to +4.5V, V<sub>L</sub> = +1.65V to +3.6V, C<sub>FLYING</sub> = 100nF, C<sub>VBUS</sub> = 1μF, ESR<sub>CVBUS</sub> = 0.1Ω (max), T<sub>A</sub> = T<sub>MIN</sub> to T<sub>MAX</sub>, unless otherwise noted. Typical values are at V<sub>CC</sub> = +3.7V, V<sub>L</sub> = +2.5V, T<sub>A</sub> = +25°C.) (Note 2)

PARAMETER	SYMBOL	CONDITIONS	MIN	TYP	MAX	UNITS
Supply Voltage	V <sub>CC</sub>		3.0		4.5	V
TRM Output Voltage	V <sub>TRM</sub>		3.0		3.6	V
Logic Supply Voltage	V <sub>L</sub>		1.65		3.60	V
V <sub>L</sub> Supply Current	I <sub>VL</sub>	I <sup>2</sup> C interface in steady state			5	μA
V <sub>CC</sub> Operating Supply Current	I <sub>CC</sub>	USB normal mode, C <sub>L</sub> = 50pF, device switching at full speed			10	mA
V <sub>CC</sub> Supply Current During Full-Speed Idle		vbus_drv = 1, I <sub>VBUS</sub> = 0		1.4	2	mA
		vbus_drv = 0, D+ = high, D- = low		0.5	0.8	
V <sub>CC</sub> Shutdown Supply Current	I <sub>CC(SHDN)</sub>			3.5	10	μA
V <sub>CC</sub> Interrupt Shutdown Supply Current	I <sub>CC(ISHDN)</sub>	ID_IN floating or high		20	30	μA
V <sub>CC</sub> Suspend Supply Current		USB suspend mode, ID_IN floating or high		170	500	μA
<b>LOGIC I/O</b>						
RCV, DAT_VP, SE0_VM, INT, OE/INT, VP, VM Output High Voltage	V <sub>OH</sub>	I <sub>OUT</sub> = 1mA (sourcing)	V <sub>L</sub> - 0.4			V
RCV, DAT_VP, SE0_VM, INT, OE/INT, VP, VM Output Low Voltage	V <sub>OL</sub>	I <sub>OUT</sub> = 1mA (sinking)		0.4		V
OE/INT, SPD, SUS, RESET, DAT_VP, SE0_VM Input High Voltage	V <sub>IH</sub>		2/3 x V <sub>L</sub>			V

# USB On-the-Go Transceiver and Charge Pump

MAX3301E

## DC ELECTRICAL CHARACTERISTICS (continued)

(V<sub>CC</sub> = +3V to +4.5V, V<sub>L</sub> = +1.65V to +3.6V, C<sub>FLYING</sub> = 100nF, C<sub>VBUS</sub> = 1μF, ESR<sub>CVBUS</sub> = 0.1Ω (max), T<sub>A</sub> = T<sub>MIN</sub> to T<sub>MAX</sub>, unless otherwise noted. Typical values are at V<sub>CC</sub> = +3.7V, V<sub>L</sub> = +2.5V, T<sub>A</sub> = +25°C.) (Note 2)

PARAMETER	SYMBOL	CONDITIONS	MIN	TYP	MAX	UNITS
OE/INT, SPD, SUS, RESET DAT_VP, SE0_VM Input Low Voltage	V <sub>IL</sub>				0.4	V
ADD Input High Voltage	V <sub>IHA</sub>		2/3 × V <sub>L</sub>			V
ADD Input Low Voltage	V <sub>ILA</sub>				1/3 × V <sub>L</sub>	V
Input Leakage Current				±1		μA
<b>TRANSCEIVER SPECIFICATIONS</b>						
Differential Receiver Input Sensitivity		V <sub>D+</sub> - V <sub>D-</sub>	0.2			V
Differential Receiver Common- Mode Voltage			0.8		2.5	V
Single-Ended Receiver Input Low Voltage	V <sub>ILD</sub>	D+, D-			0.8	V
Single-Ended Receiver Input High Voltage	V <sub>IHD</sub>	D+, D-	2.0			V
Single-Ended Receiver Hysteresis				0.2		V
Single-Ended Output Low Voltage	V <sub>OLD</sub>	D+, D-, R <sub>L</sub> = 1.5kΩ from D+ or D- to 3.6V			0.3	V
Single-Ended Output High Voltage	V <sub>OHD</sub>	D+, D-, R <sub>L</sub> = 15kΩ from D+ or D- to GND	2.8		3.6	V
Off-State Leakage Current		D+, D-			±1	μA
Driver Output Impedance		D+, D-, not including R <sub>EXT</sub>				Ω
			Low steady-state drive		2	13
			High steady-state drive		2	13
<b>ESD PROTECTION (V<sub>BUS</sub>, ID_IN, D+, D-)</b>						
Human Body Model				±15		kV
IEC 61000-4-2 Air-Gap Discharge				±10		kV
IEC 61000-4-2 Contact Discharge				±6		kV
<b>THERMAL SHUTDOWN</b>						
Thermal Shutdown Low-to-High				+160		°C
Thermal Shutdown High-to-Low				+150		°C
<b>CHARGE-PUMP SPECIFICATIONS (vbus_drv = 1)</b>						
V <sub>BUS</sub> Output Voltage	V <sub>BUS</sub>	3V < V <sub>CC</sub> < 4.5V, C <sub>VBUS</sub> = 10μF, I <sub>VBUS</sub> = 8mA	4.80		5.25	V
V <sub>BUS</sub> Output Current	I <sub>VBUS</sub>		8			mA
V <sub>BUS</sub> Output Ripple		I <sub>VBUS</sub> = 8mA, C <sub>VBUS</sub> = 10μF		100		mV

# USB On-the-Go Transceiver and Charge Pump

MAX3301E

## DC ELECTRICAL CHARACTERISTICS (continued)

(V<sub>CC</sub> = +3V to +4.5V, V<sub>L</sub> = +1.65V to +3.6V, C<sub>FLYING</sub> = 100nF, C<sub>VBUS</sub> = 1μF, ESR<sub>CVBUS</sub> = 0.1Ω (max), T<sub>A</sub> = T<sub>MIN</sub> to T<sub>MAX</sub>, unless otherwise noted. Typical values are at V<sub>CC</sub> = +3.7V, V<sub>L</sub> = +2.5V, T<sub>A</sub> = +25°C.) (Note 2)

PARAMETER	SYMBOL	CONDITIONS	MIN	TYP	MAX	UNITS
Switching Frequency	f <sub>SW</sub>			390		kHz
V <sub>BUS</sub> Leakage Voltage		vbus_drv = 0			0.2	V
V <sub>BUS</sub> Rise Time		C <sub>VBUS</sub> = 10μF, I <sub>VBUS</sub> = 8mA, measured from 0 to +4.4V			100	ms
V <sub>BUS</sub> Pulldown Resistance		vbus_dischrg = 1, vbus_drv = 0, vbus_chrg = 0	3.8	5	6.5	kΩ
V <sub>BUS</sub> Pullup Resistance		vbus_chrg = 1, vbus_drv = 0, vbus_dischrg = 0	650	930	1250	Ω
V <sub>BUS</sub> Input Impedance	Z <sub>INVBUS</sub>	vbus_dischrg = 0, vbus_drv = 0, vbus_chrg = 0	40	70	100	kΩ
<b>COMPARATOR SPECIFICATIONS</b>						
V <sub>BUS</sub> Valid Comparator Threshold	V <sub>TH-VBUS</sub>		4.4	4.6	4.8	V
V <sub>BUS</sub> Valid Comparator Hysteresis	V <sub>HYS-VBUS</sub>			50		mV
Session-Valid Comparator Threshold	V <sub>TH-SESS_VLD</sub>		0.8	1.4	2.0	V
Session-End Comparator Threshold	V <sub>TH-SESS_END</sub>		0.2	0.5	0.8	V
dp_hi Comparator Threshold			0.8	1.3	2.0	V
dm_hi Comparator Threshold			0.8	1.3	2.0	V
cr_int Pulse Width				750		ns
cr_int Comparator Threshold			0.4	0.5	0.6	V
<b>ID_IN SPECIFICATIONS</b>						
ID_IN Input Voltage for Car Kit			0.2 x V <sub>CC</sub>		0.8 x V <sub>CC</sub>	V
ID_IN Input Voltage for A Device					0.1 x V <sub>CC</sub>	V
ID_IN Input Voltage for B Device			0.9 x V <sub>CC</sub>			V
ID_IN Input Impedance	Z <sub>ID_IN</sub>		70	100	130	kΩ
ID_IN Input Leakage Current		ID_IN = V <sub>CC</sub>	-1		+1	μA
ID_IN Pulldown Resistance		id_pulldown = 1		150	300	Ω
<b>TERMINATING RESISTOR SPECIFICATIONS (D+, D-)</b>						
D+ Pulldown Resistor		dp_pulldown = 1	14.25	15	15.75	kΩ
D- Pulldown Resistor		dm_pulldown = 1	14.25	15	15.75	kΩ
D+ Pullup Resistor		dp_pullup = 1	1.425	1.5	1.575	kΩ
D- Pullup Resistor		dm_pullup = 1	1.425	1.5	1.575	kΩ

# USB On-the-Go Transceiver and Charge Pump

MAX3301E

## TIMING CHARACTERISTICS

(V<sub>CC</sub> = +3V to +4.5V, V<sub>L</sub> = +1.65V to +3.6V, C<sub>FLYING</sub> = 100nF, C<sub>VBUS</sub> = 1μF, ESR<sub>CVBUS</sub> = 0.1Ω (max), T<sub>A</sub> = T<sub>MIN</sub> to T<sub>MAX</sub>, unless otherwise noted. Typical values are at V<sub>CC</sub> = +3.7V, V<sub>L</sub> = +2.5V, T<sub>A</sub> = +25°C.) (Note 2)

PARAMETER	SYMBOL	CONDITIONS	MIN	TYP	MAX	UNITS
<b>TRANSMITTER CHARACTERISTICS (FULL-SPEED MODE)</b>						
D+, D- Rise Time	t <sub>R</sub>	Figures 2 and 5	4		20	ns
D+, D- Fall Time	t <sub>F</sub>	Figures 2 and 5	4		20	ns
Rise-/Fall-Time Matching		Figures 2 and 5 (Note 3)	90		110	%
Output-Signal Crossover Voltage	V <sub>CRS_F</sub>	Figures 2, 6, and 7 (Note 3)	1.3		2.0	V
<b>TRANSCIEVER CHARACTERISTICS (LOW-SPEED MODE)</b>						
D+, D- Rise Time	t <sub>R</sub>	Figures 2 and 5	75		300	ns
D+, D- Fall Time	t <sub>F</sub>	Figures 2 and 5	75		300	ns
Rise-/Fall-Time Matching		Figures 2 and 5	80		125	%
Output-Signal Crossover Voltage	V <sub>CRS_L</sub>	Figures 2, 6, and 7	1.3		2.0	V
<b>TRANSMITTER TIMING (FULL-SPEED MODE)</b>						
Driver Propagation Delay (DAT_VP, SE0_VM to D+, D-)	t <sub>PLH</sub>	Low-to-high, Figures 2 and 6			25	ns
	t <sub>PHL</sub>	High-to-low, Figures 2 and 6			25	
Driver Disable Delay	t <sub>PDZ</sub>	Figures 1 and 8			25	ns
Driver Enable Delay	t <sub>PZD</sub>	Figures 2 and 8			25	ns
<b>TRANSMITTER TIMING (LOW-SPEED MODE) (Low-speed delay timing is dominated by the slow rise and fall times.)</b>						
<b>SPEED-INDEPENDENT TIMING CHARACTERISTICS</b>						
Receiver Disable Delay	t <sub>PVZ</sub>	Figure 4			30	ns
Receiver Enable Delay	t <sub>PZV</sub>	Figure 4			30	ns
D+ Pullup Assertion Time		During HNP			3	μs
RCV Rise Time	t <sub>R</sub>	Figures 3 and 5, C <sub>L</sub> = 15pF		4		ns
RCV Fall Time	t <sub>F</sub>	Figures 3 and 5, C <sub>L</sub> = 15pF		4		ns
Differential-Receiver Propagation Delay	t <sub>PHL</sub> , t <sub>PLH</sub>	Figures 3 and 10, ID+ - D-I to DAT_VP			30	ns
		Figures 3 and 9, ID+ - D-I to RCV			30	
Single-Ended-Receiver Propagation Delay	t <sub>PHL</sub> , t <sub>PLH</sub>	Figures 3 and 9, D+, D- to DAT_VP, SE0_VM			30	ns
Interrupt Propagation Delay					100	μs
V <sub>BUS</sub> _CHRG Propagation Delay		Dominated by the V <sub>BUS</sub> rise time		0.2		μs
Time to Exit Shutdown					1	μs
Shutdown Delay					10	μs

# USB On-the-Go Transceiver and Charge Pump

**MAX3301E**

## I<sup>2</sup>C-/SMBus™- COMPATIBLE TIMING SPECIFICATIONS

(V<sub>CC</sub> = +3V to +4.5V, V<sub>L</sub> = +1.65V to +3.6V, C<sub>FLYING</sub> = 100nF, C<sub>VBUS</sub> = 1μF, ESR<sub>CVBUS</sub> = 0.1Ω (max), T<sub>A</sub> = T<sub>MIN</sub> to T<sub>MAX</sub>, unless otherwise noted. Typical values are at V<sub>CC</sub> = +3.7V, V<sub>L</sub> = +2.5V, T<sub>A</sub> = +25°C.) (Note 2)

PARAMETER	SYMBOL	CONDITIONS	MIN	TYP	MAX	UNITS
Serial Clock Frequency	f <sub>SCL</sub>				400	kHz
Bus-Free Time Between Stop and Start Conditions	t <sub>BUF</sub>		1.3			μs
Start-Condition Hold Time	t <sub>HD_STA</sub>		0.6			μs
Stop-Condition Setup Time	t <sub>SU_STO</sub>		0.6			μs
Clock Low Period	t <sub>LOW</sub>		1.3			μs
Clock High Period	t <sub>HIGH</sub>		0.6			μs
Data Setup Time	t <sub>SU_DAT</sub>		100			ns
Data Hold Time	t <sub>HD_DAT</sub>	(Note 4)			0.9	μs
Rise Time of SDA and SCL	t <sub>R</sub>	(Note 5)	20 + 0.1 x C <sub>B</sub>		300	ns
Fall Time of SDA and SCL	t <sub>F</sub>	Measured from 0.3 x V <sub>L</sub> to 0.7 x V <sub>L</sub> (Note 5)			300	ns
Capacitive Load for each Bus Line	C <sub>B</sub>				400	pF
<b>SDA AND SCL I/O STAGE CHARACTERISTICS</b>						
Input-Voltage Low	V <sub>IL</sub>				0.3 x V <sub>L</sub>	V
Input-Voltage High	V <sub>IH</sub>		0.7 x V <sub>L</sub>			V
SDA Output-Voltage Low	V <sub>OL</sub>	I <sub>SINK</sub> = 3mA			0.4	V
Pulse Width of Suppressed Spike	t <sub>SP</sub>	(Note 6)		50		ns

**Note 2:** Parameters are 100% production tested at +25°C. Limits over temperature are guaranteed by design.

**Note 3:** Guaranteed by bench characterization. Limits are not production tested.

**Note 4:** A master device must provide a hold time of at least 300ns for the SDA signal to bridge the undefined region of SCL's falling edge.

**Note 5:** C<sub>B</sub> is the total capacitance of one bus line in pF, tested with C<sub>B</sub> = 400pF.

**Note 6:** Input filters on SDA, SCL, and ADD suppress noise spikes of less than 50ns.

SMBus™ is a trademark of Intel Corporation.

# USB On-the-Go Transceiver and Charge Pump

## Typical Operating Characteristics

(Typical operating circuit,  $V_{CC} = +3.7V$ ,  $V_L = +2.5V$ ,  $C_{FLYING} = 100nF$ ,  $T_A = +25^\circ C$ , unless otherwise noted.)

MAX3301E

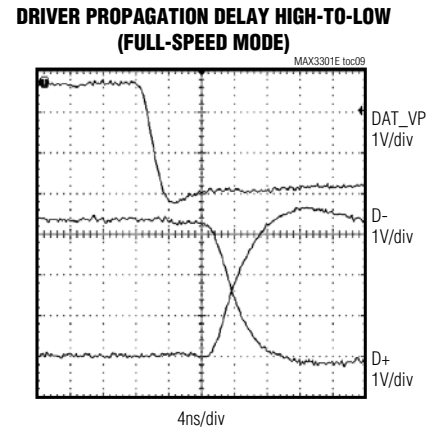
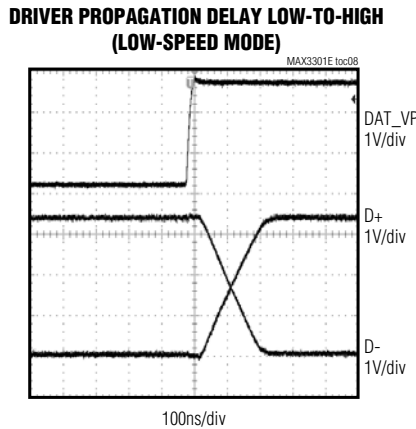
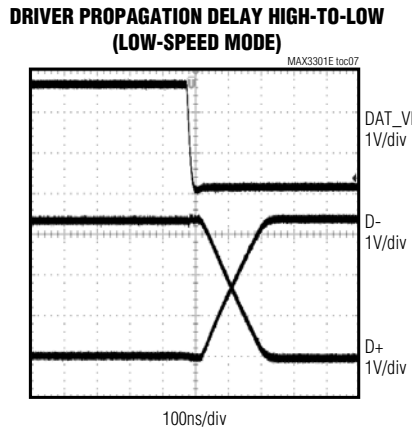
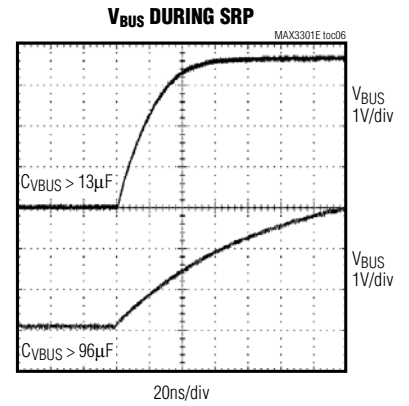
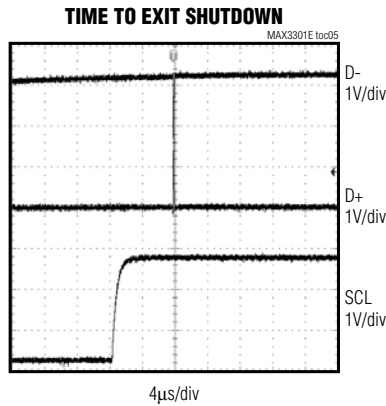
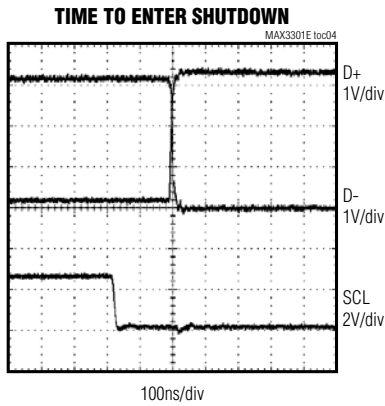
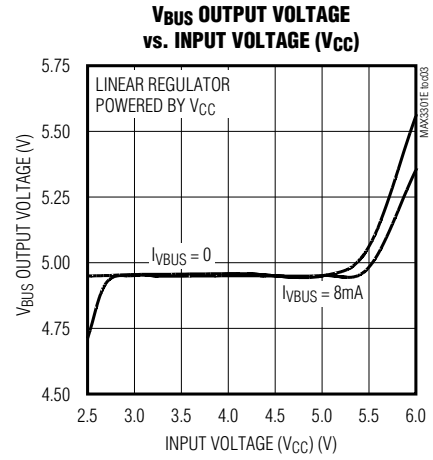
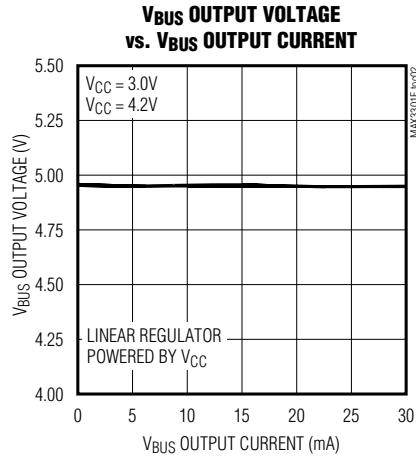
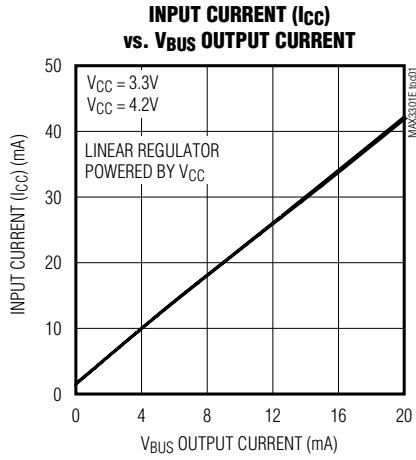

# USB On-the-Go Transceiver and Charge Pump

## Typical Operating Characteristics (continued)

(Typical operating circuit,  $V_{CC} = +3.7V$ ,  $V_L = +2.5V$ ,  $C_{FLYING} = 100nF$ ,  $T_A = +25^\circ C$ , unless otherwise noted.)

**DRIVER PROPAGATION DELAY LOW-TO-HIGH (FULL-SPEED MODE)**

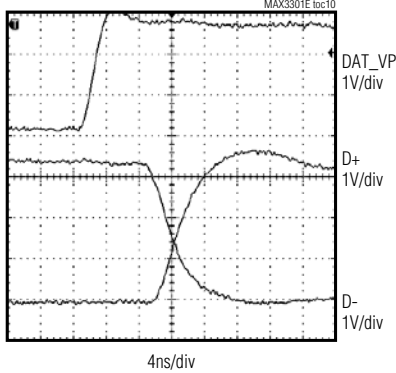

4ns/div

**DRIVER ENABLE DELAY (FULL-SPEED MODE)**

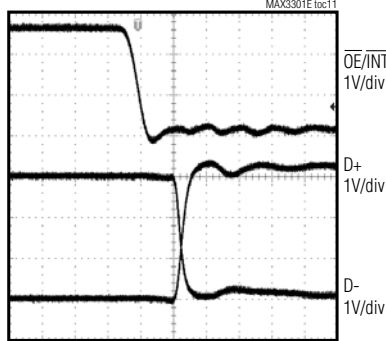

10ns/div

**DRIVER DISABLE DELAY (FULL-SPEED MODE)**

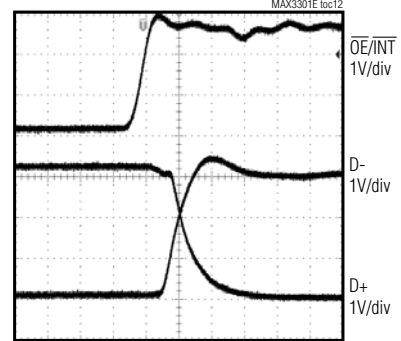

10ns/div

**DRIVER ENABLE DELAY (LOW-SPEED MODE)**

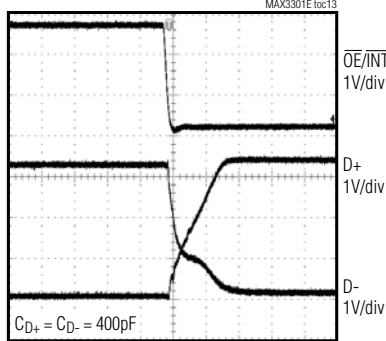

100ns/div

**DRIVER DISABLE DELAY (LOW-SPEED MODE)**

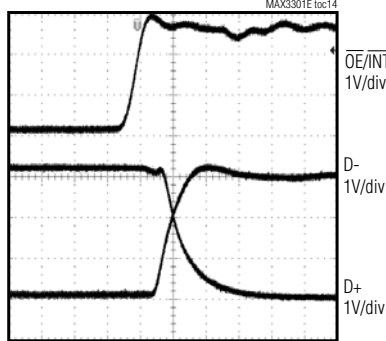

10ns/div

**SUPPLY CURRENT vs. TEMPERATURE**

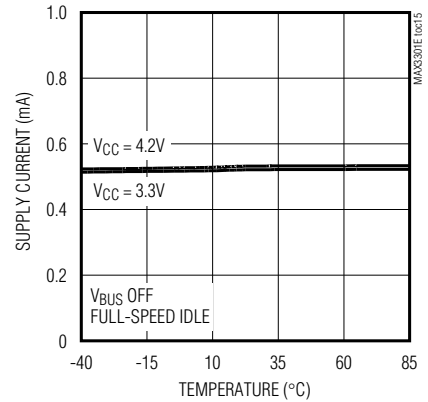



# USB On-the-Go Transceiver and Charge Pump

## Pin Description

**MAX3301E**

PIN		NAME	FUNCTION
THIN QFN	UCSP		
1, 4, 9, 12, 17, 25, 28	—	N.C.	No Connection. Not internally connected.
2	D2	DAT_VP	System-Side Data Input/Output. DAT_VP is an input if $\overline{OE}/\overline{INT}$ is logic 0. DAT_VP is an output if $\overline{OE}/\overline{INT}$ is logic 1. Program the function of DAT_VP with the dat_se0 bit (bit 2 of control register 1, see Table 7).
3, 29	D1, E3	V <sub>CC</sub>	Input Power Supply. Connect a +3V to +4.5V supply to V <sub>CC</sub> and bypass to GND with a 1μF capacitor. The supply range enables direct powering from one Li+ battery.
5	C1	C-	Charge-Pump Flying-Capacitor Negative Terminal
6	C2	SE0_VM	System-Side Data Input/Output. SE0_VM is an input if $\overline{OE}/\overline{INT}$ is logic 0. SE0_VM is an output if $\overline{OE}/\overline{INT}$ is logic 1. Program the function of SE0_VM with the dat_se0 bit (bit 2 of control register 1, see Table 7).
7, 21	B1, C5	GND	Ground
8	A1	SDA	I <sup>2</sup> C-Compatible Serial Data Interface. Open-drain data input/output.
10	B2	SCL	I <sup>2</sup> C-Compatible Serial Clock Input
11	A2	$\overline{OE}/\overline{INT}$	Output Enable. $\overline{OE}/\overline{INT}$ controls the input or output status of DAT_VP/SE0_VM and D+/D-. When $\overline{OE}/\overline{INT}$ is logic 0, the device is in transmit mode. When $\overline{OE}/\overline{INT}$ is logic 1, the device is in receive mode. When in suspend mode, $\overline{OE}/\overline{INT}$ can be programmed to function as an interrupt output that detects the same interrupts as $\overline{INT}$ . The oe_int_en bit (bit 5 of control register 1, see Table 7) enables and disables the interrupt circuitry of $\overline{OE}/\overline{INT}$ . The irq_mode bit (bit 1 of special-function register 1, see Table 14) programs the output configuration of $\overline{INT}$ and $\overline{OE}/\overline{INT}$ as open-drain or push-pull.
13	A3	RCV	D+ and D- Differential Receiver Output. In receive mode (see Table 4), when D+ is high and D- is low, RCV is high. In receive mode, when D+ is low and D- is high, RCV is low. RCV is low in suspend mode.
14	B3	SPD	Speed-Selector Input. Connect SPD to GND to select the low-speed data rate (1.5Mbps). Connect SPD to V <sub>L</sub> to select the full-speed data rate (12Mbps). Disable the SPD input by writing a 1 to spd_susp_ctl (bit 1 in special-function register 1, see Table 14). The speed bit (bit 0 of control register 1, see Table 7) determines the maximum data rate of the MAX3301E when the SPD input is disabled.
15	A4	V <sub>L</sub>	System-Side Logic-Supply Input. Connect to the system's logic-level power supply, +1.65V to +3.6V. This sets the maximum output levels of the logic outputs and the input thresholds of the logic inputs. Bypass to GND with a 0.1μF capacitor.
16	A5	SUS	Active-High Suspend Input. Drive SUS low for normal USB operation. Drive SUS high to enable suspend mode. RCV asserts low in suspend mode. Disable the SUS input by writing a 1 to spd_susp_ctl (bit 1 in special-function register 1, see Table 14). The suspend bit (bit 1 of control register 1, see Table 7) determines the operating mode of the MAX3301E when the SUS input is disabled.
18	B4	$\overline{INT}$	Active-Low Interrupt Source. Program the $\overline{INT}$ output as push-pull or open-drain with the irq_mode bit (bit 1 of special-function register 2, see Table 15).
19	B5	$\overline{RESET}$	Active-Low Reset Input. Drive $\overline{RESET}$ low to asynchronously reset the MAX3301E.

# USB On-the-Go Transceiver and Charge Pump

## Pin Description (continued)

PIN		NAME	FUNCTION
THIN QFN	UCSP		
20	C3	ADD	I <sup>2</sup> C-Interface Address Selection Input. (See Table 5.)
22	C4	ID_IN	ID Input. ID_IN is internally pulled up to V <sub>CC</sub> . The state of ID_IN determines ID bits 3 and 5 of the interrupt source register (see Table 10).
23	D5	D-	USB Differential Data Input/Output. Connect D- to the D- terminal of the USB connector through a 27.4Ω ±1% series resistor.
24	E5	D+	USB Differential Data Input/Output. Connect D+ to the D+ terminal of the USB connector through a 27.4Ω ±1% series resistor.
26	D4	VM	Single-Ended Receiver Output. VM functions as a receiver output in all operating modes. VM duplicates D-.
27	E4	TRM	USB Transceiver Regulated Output Voltage. TRM provides a regulated 3.3V output. Bypass TRM to GND with a 1μF ceramic capacitor installed as close to the device as possible. TRM normally derives power from V <sub>CC</sub> . TRM provides power to internal circuitry and provides the pullup voltage for the internal USB pullup resistor. Do not use TRM to power external circuitry. The reg_sel bit (bit 3 of special-function register 2, see Table 15) controls the TRM power source with software.
30	D3	VP	Single-Ended Receiver Output. VP functions as a receiver output in all operating modes. VP duplicates D+.
31	E2	V <sub>BUS</sub>	USB Bus Power. Use V <sub>BUS</sub> as an output to power the USB bus, or as an input to power the internal linear regulator. Bits 5 to 7 of control register 2 (see Table 8) control the charging and discharging functions of V <sub>BUS</sub> .
32	E1	C+	Charge-Pump Flying-Capacitor Positive Terminal
EP	—	EP	Exposed Paddle. Connect to GND or leave floating

## Test Circuits and Timing Diagrams

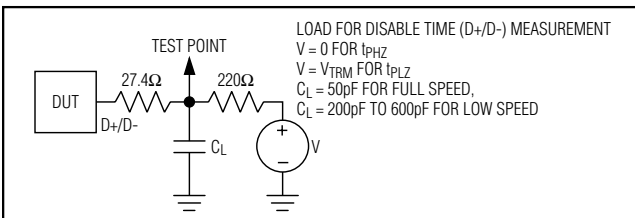

Figure 1. Load for Disable Time Measurement

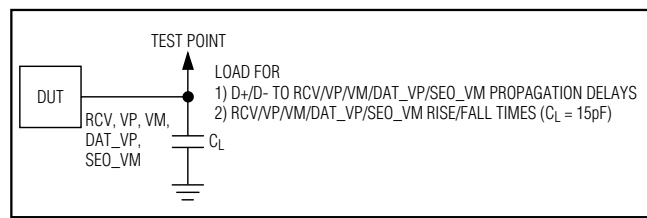

Figure 3. Load for Receiver Propagation Delay and Receiver Rise/Fall Times

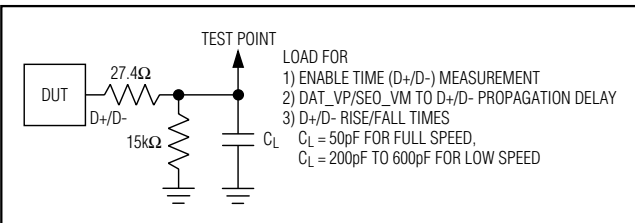

Figure 2. Load for Enable Time, Transmitter Propagation Delay, and Transmitter Rise/Fall Times

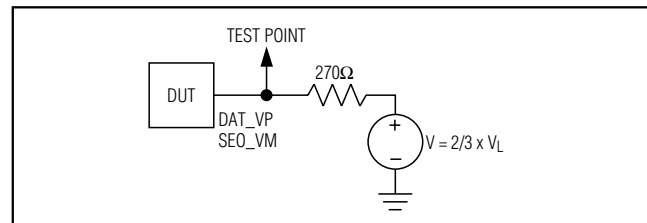

Figure 4. Load for DAT\_VP, SEO\_VM Enable/Disable Time Measurements

# USB On-the-Go Transceiver and Charge Pump

MAX3301E

## Test Circuits and Timing Diagrams (continued)

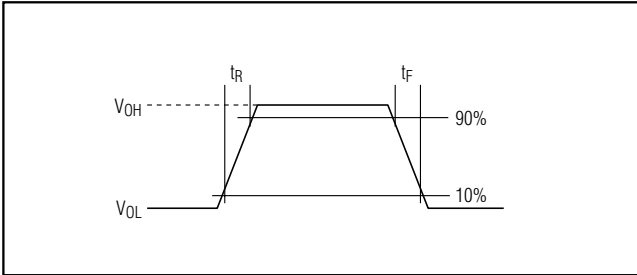

Figure 5. Rise and Fall Times

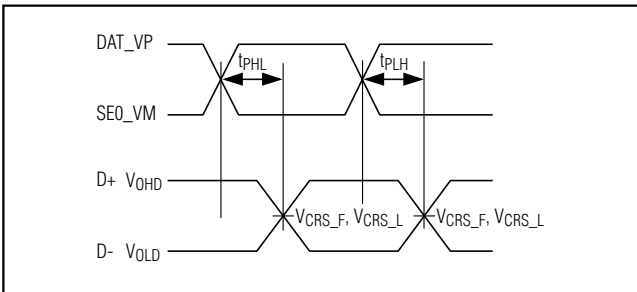

Figure 6. Timing of DAT\_VP, SEQ\_VM to D+, D- in VP\_VM Mode ( $dat\_se0 = 0$ )

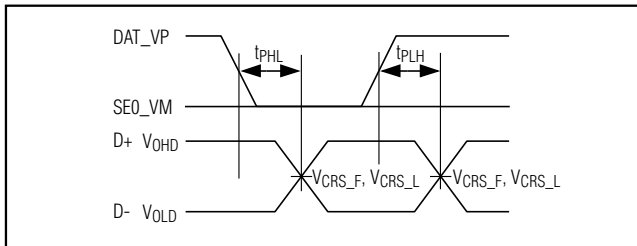

Figure 7. Timing of DAT\_VP, SEQ\_VM to D+/D- in DAT\_SE0 Mode ( $dat\_se0 = 1$ )

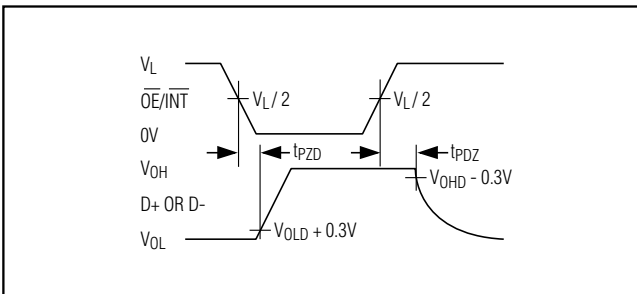

Figure 8. Enable and Disable Timing

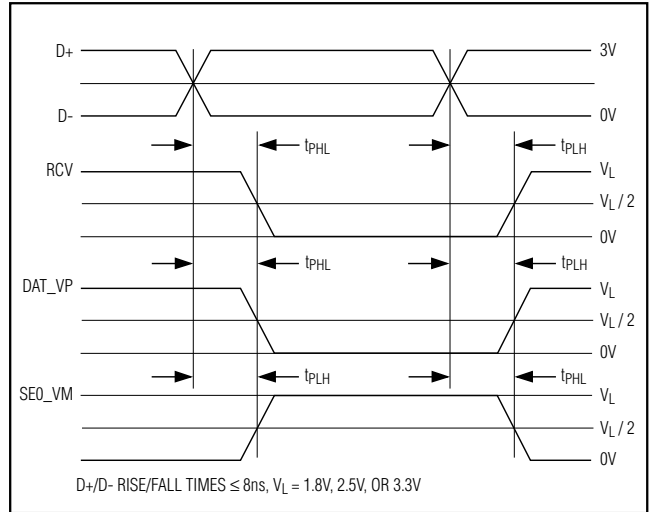

Figure 9. D+/D- to RCV, DAT\_VP, SEQ\_VM Propagation Delays (VP\_VM Mode)

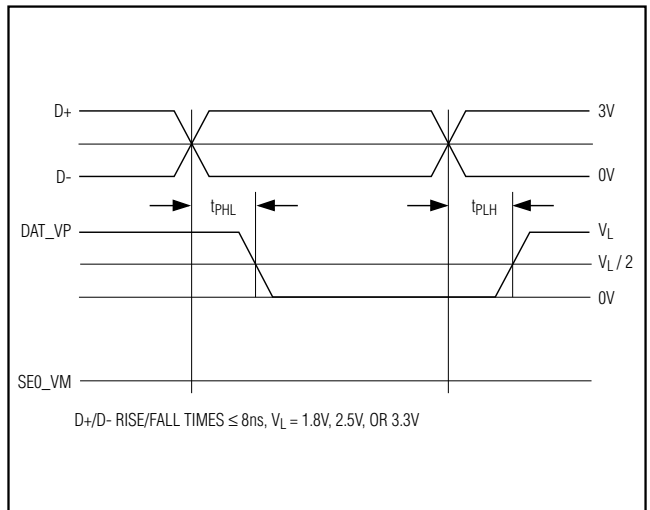

Figure 10. D+/D- to DAT\_VP, SEQ\_VM Propagation Delays (DAT\_SE0 Mode)

# USB On-the-Go Transceiver and Charge Pump

## Block Diagram

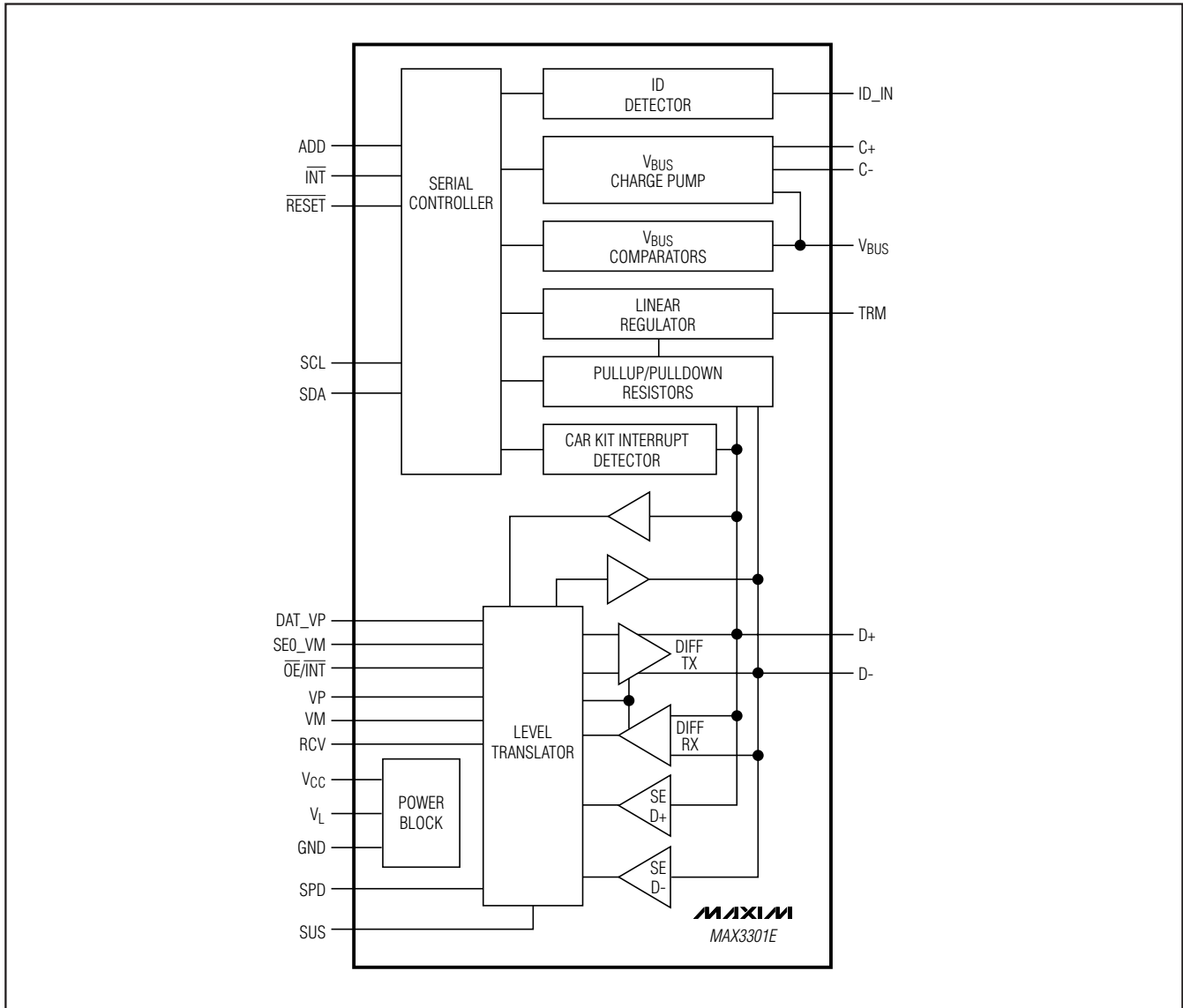

Figure 11. Block Diagram

# USB On-the-Go Transceiver and Charge Pump

## Detailed Description

The USB OTG specification defines a dual-role USB device that acts either as an A device or as a B device. The A device supplies power on  $V_{BUS}$  and initially serves as the USB host. The B device serves as the initial peripheral and requires circuitry to monitor and pulse  $V_{BUS}$ . These initial roles can be reversed using HNP.

The MAX3301E combines a low- and full-speed USB transceiver with additional circuitry required by a dual-role device. The MAX3301E employs flexible switching circuitry to enable the device to act as a dedicated host or peripheral USB transceiver. For example, the charge pump can be turned off and the internal regulator can be powered from  $V_{BUS}$  for bus-powered peripheral applications.

### Transceiver

The MAX3301E transceiver complies with the USB version 2.0 specification, and operates at full-speed (12Mbps) and low-speed (1.5Mbps) data rates. Set the data rate with the SPD input. Set the direction of data transfer with the  $\overline{OE}/\overline{INT}$  input. Alternatively, control transceiver operation with control register 1 (Table 7) and special-function registers 1 and 2 (see Tables 14 and 15).

### Level Shifters

Internal level shifters allow the system-side interface to run at logic-supply voltages as low as +1.65V. Interface logic signals are referenced to the voltage applied to the logic-supply voltage,  $V_L$ .

### Charge Pump

The MAX3301E's OTG-compliant charge pump operates with +3V to +4.5V input supply voltages ( $V_{CC}$ ) and supplies a +4.8V to +5.25V OTG-compatible output on  $V_{BUS}$  while sourcing the 8mA or greater output current that an A device is required to supply. Connect a 0.1 $\mu$ F flying capacitor between C+ and C-. Bypass  $V_{BUS}$  to GND with a 1 $\mu$ F to 6.5 $\mu$ F capacitor, in accordance with USB OTG specifications. The charge pump can be turned off to conserve power when not used. Control of the charge pump is set through the `vbus_drv` bit (bit 5) of control register 2 (see Table 8).

### Linear Regulator (TRM)

An internal 3.3V linear regulator powers the transceiver and the internal 1.5k $\Omega$  D+/D- pullup resistor. Under the control of internal register bits, the linear regulator can be powered from  $V_{CC}$  or  $V_{BUS}$ . The regulator power-supply settings are controlled by the `reg_sel` bit (bit 3) in special-function register 2 (see Table 15). This flexibility

allows the system designer to configure the MAX3301E for virtually any USB power situation.

The output of the TRM is not a power supply. Do not use as a power source for any external circuitry. Connect a 1.0 $\mu$ F (or greater) ceramic or plastic capacitor from TRM to GND, as close to the device as possible.

### $V_{BUS}$ Level-Detection Comparators

Comparators drive interrupt source register bits 0, 1, and 7 (Table 10) to indicate important USB OTG  $V_{BUS}$  voltage levels:

- $V_{BUS}$  is valid (`vbus_vld`)
- USB session is valid (`sess_vld`)
- USB session has ended (`sess_end`)

The `vbus_valid` comparator sets `vbus_vld` to 1 if  $V_{BUS}$  is higher than the  $V_{BUS}$  valid comparator threshold. The  $V_{BUS}$  valid status bit (`vbus_vld`) is used by the A device to determine if the B device is sinking too much current (i.e., is not supported). The `session_valid` comparator sets `sess_vld` to 1 if  $V_{BUS}$  is higher than the session valid comparator threshold. This status bit indicates that a data transfer session is valid. The `session_end` comparator sets `sess_end` to 1 if  $V_{BUS}$  is higher than the session end comparator threshold. Figure 12 shows the level-detector comparators. The interrupt-enable registers (Tables 12 and 13) determine whether a falling or rising edge of  $V_{BUS}$  asserts these status bits.

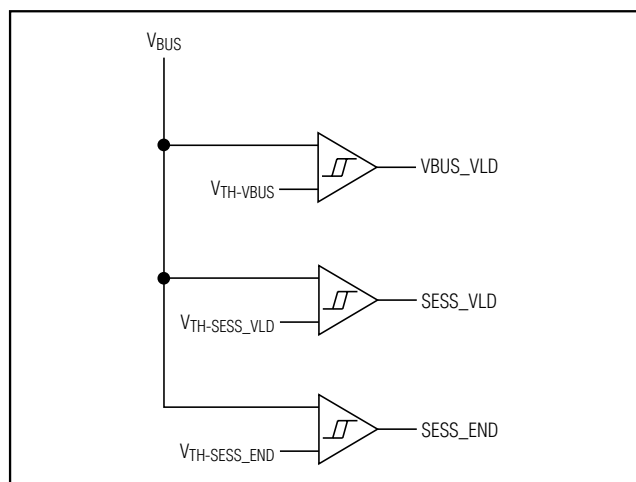

Figure 12. Comparator Network Diagram

# USB On-the-Go Transceiver and Charge Pump

## ID\_IN

The USB OTG specification defines an ID input that determines which dual-role device is the default host. An OTG cable connects ID to ground in the connector of one end and is left unconnected in the other end. Whichever dual-role device receives the grounded end becomes the A device. The MAX3301E provides an internal pullup resistor on ID\_IN. Internal comparators detect if ID\_IN is grounded or left floating.

## Interrupt Logic

When OTG events require action, the MAX3301E provides an interrupt output signal on  $\overline{\text{INT}}$ . Alternatively,  $\overline{\text{OE/INT}}$  can be configured to act as an interrupt output while the device operates in USB suspend mode. Program  $\overline{\text{INT}}$  and  $\overline{\text{OE/INT}}$  as open-drain or push-pull interrupts with *irq\_mode* (bit 1 of special-function register 2, see Table 15).

## VBUS Power Control

VBUS is a dual-function port that powers the USB bus and/or provides a power source for the internal linear regulator. The VBUS power-control block performs the various switching functions required by an OTG dual-role device. These actions are programmed by the system logic using bits 5 to 7 of control register 2 (see Table 8) to:

- Discharge VBUS through a resistor
- Provide power-on or receive power from VBUS
- Charge VBUS through a resistor

The OTG supplement allows an A device to turn VBUS off when the bus is not being used to conserve power. The B device can issue a request that a new session be started using SRP. The B device must discharge VBUS to a level below the session-end threshold (0.8V) to

ensure that no session is in progress before initiating SRP. Setting bit 6 of control register 2 to a 1, discharges VBUS to GND through a 5k $\Omega$  current-limiting resistor. When VBUS has discharged, the resistor is removed from the circuit by resetting bit 6 of control register 2.

An OTG A device is required to supply power on VBUS. The MAX3301E provides power to VBUS from VCC or from the internal charge pump. Set bit 5 in control register 2 to a 1 in both cases. Bit 5 in control register 2 controls a current-limited switch, preventing damage to the device in the event of a VBUS short circuit.

An OTG B device (peripheral mode) can request a session using SRP. One of the steps in implementing SRP requires pulsing VBUS high for a controlled time. A 930 $\Omega$  resistor limits the current according to the OTG specification. Pulse VBUS through the pullup resistor by asserting bit 7 of control register 2. Prior to pulsing VBUS (bit 7), a B device first connects an internal pulldown resistor to discharge VBUS below the session-end threshold. The discharge current is limited by the 5k $\Omega$  resistor and set by bit 6 of control register 2. An OTG A device must supply 5V power and at least 8mA on VBUS. Setting bit 5 of control register 2 turns on the VBUS charge pump.

## Operating Modes

The MAX3301E has four operating modes to optimize power consumption. Only the I<sup>2</sup>C interface remains active in shutdown mode, reducing supply current to 1 $\mu$ A. The I<sup>2</sup>C interface, the ID\_IN port, and the session-valid comparator all remain active in interrupt shutdown mode. RCV asserts low in suspend mode; however, all other circuitry remains active. Table 1 lists the active blocks' power in each of the operating modes.

**Table 1. Functional Blocks Enabled During Specific Operating Modes**

MODE	I <sup>2</sup> C	ID_IN	sess_end COMP	sess_vld COMP	vbus_vld COMP	cr_int COMP	dp_hi COMP	dm_hi COMP	TRM	TX	DIFF RX	SE RX
Shutdown <sup>1</sup>	✓	X	X	X	X	X	X	X	X	X	X	X
Interrupt Shutdown <sup>2</sup>	✓	✓	X	✓	X	X	✓	✓	X	X	X	X
Suspend <sup>3</sup>	✓	✓	✓	✓	✓	✓	✓	✓	✓	✓	X	✓
Normal Operating	✓	✓	✓	✓	✓	✓	✓	✓	✓	✓	✓	✓

✓ = Enabled.  
X = Disabled.

1. Enter shutdown mode by writing a 1 to *sdwn* (bit 0 of special-function register 2).

2. Enter interrupt shutdown mode by writing a 1 to *int\_sdwn* (bit 0 of special-function register 1).

3. Enter suspend mode by writing a 1 to *spd\_susp\_ctl* (bit 1 of special-function register 1) and *suspend* (bit 1 of control register 1), or by writing a 0 to *spd\_susp\_ctl* (bit 1 of special-function register 1) and driving *SUS* high.

# USB On-the-Go Transceiver and Charge Pump

MAX3301E

## Applications Information

### Data Transfer

#### Transmitting Data to the USB

The MAX3301E transceiver features two modes of transmission: DAT\_SE0 or VP\_VM (see Table 3). Set the transmitting mode with `dat_se0` (bit 2 in control register 1, see Table 7). In DAT\_SE0 mode with  $\overline{OE/INT}$  low, DAT\_VP specifies data for the differential transceiver, and SE0\_VM forces D+/D- to the single-ended zero (SE0) state. In VP\_VM mode with  $\overline{OE/INT}$  low, DAT\_VP drives D+, and SE0\_VM drives D-. The differential receiver determines the state of RCV.

#### Receiving Data from the USB

The MAX3301E transceiver features two modes of receiving data: DAT\_SE0 or VP\_VM (see Table 4). Set the receiving mode with `dat_se0` (bit 2 in control register 1, see Table 7). In DAT\_SE0 mode with  $\overline{OE/INT}$  high, DAT\_VP is the output of the differential receiver and SE0\_VM indicates that D+ and D- are both logic-low. In VP\_VM mode with  $\overline{OE/INT}$  high, DAT\_VP provides the input logic level of D+ and SE0\_VM provides the input logic level of D-. The differential receiver determines the state of RCV. VP and VM echo D+ and D-, respectively.

#### $\overline{OE/INT}$

$\overline{OE/INT}$  controls the direction of communication.  $\overline{OE/INT}$  can also be programmed to act as an interrupt output when in suspend mode. The output enable portion controls the input or output status of DAT\_VP/SE0\_VM and D+/D-. When  $\overline{OE/INT}$  is a logic 0, DAT\_VP and SE0\_VM function as inputs to the D+ and D- outputs in a method depending on the status of `dat_se0` (bit 2 in control register 1). When  $\overline{OE/INT}$  is a logic 1, DAT\_VP and SE0\_VM indicate the activity of D+ and D-.

$\overline{OE/INT}$  functions as an interrupt output when the MAX3301E is in suspend mode and `oe_int_en = 1` (bit 5 in control register 1, see Table 7). In this mode,  $\overline{OE/INT}$  detects the same interrupts as  $\overline{INT}$ . Set `irq_mode` (bit 1 in special-function register 2, see Table 15) to a 0 to program  $\overline{OE/INT}$  as an open-drain interrupt output. Set `irq_mode` to a 1 to configure  $\overline{OE/INT}$  as a push-pull interrupt output.

#### RCV

RCV monitors D+ and D- when receiving data. RCV is a logic 1 for D+ high and D- low. RCV is a logic 0 for D+ low and D- high. RCV retains its last valid state when D+ and D- are both low (single-ended zero, or SE0). RCV asserts low in suspend mode. Table 4 shows the state of RCV.

#### SPD

Use hardware or software to control the slew rate of the D+ and D- terminals. The SPD input sets the slew rate of the MAX3301E when `spd_susp_ctl` (bit 1 in special-function register 1, see Table 14) is 0. Drive SPD low to select low-speed mode (1.5Mbps). Drive SPD high to select full-speed mode (12Mbps). Alternatively, when `spd_susp_ctl` (bit 1 of special-function register 1) is a 1, software controls the slew rate. The SPD input is ignored when using software to control the data rate. The speed bit (bit 0 of control register 1, see Table 7) sets the slew rate when `spd_susp_ctl = 1`.

#### SUS

Use hardware or software to control the suspend mode of the MAX3301E. Set `spd_susp_ctl` (bit 1 of special-function register 1, see Table 14) to 0 to allow the SUS input to enable and disable the suspend mode of the MAX3301E. Drive SUS low for normal operation. Drive SUS high to enable suspend mode. RCV asserts low in suspend mode while all other circuitry remains active.

Alternatively, when the `spd_susp_ctl` bit (bit 1 of special-function register 1) is set to a 1, software controls the suspend mode. Set the suspend bit (bit 1 of control register 1, see Table 7) to a 1 to enable suspend mode. Set the suspend bit to zero to resume normal operation. The SUS input is ignored when using software to control suspend mode. The MAX3301E must be in full-speed mode (`SPD = high` or `speed = 1`) to issue a remote wake-up from the device when in suspend mode.

#### RESET

The active-low  $\overline{RESET}$  input allows the MAX3301E to be asynchronously reset without cycling the power supply. Drive  $\overline{RESET}$  low to reset the internal registers (see Tables 7–15 for the default power-up states). Drive  $\overline{RESET}$  high for normal operation.

#### 2-Wire I<sup>2</sup>C-Compatible Serial Interface

A register file controls the various internal switches and operating modes of the MAX3301E through a simple 2-wire interface operating at clock rates up to 400kHz. This interface supports data bursting, where multiple data phases can follow a single address phase.

#### UART Mode

Set `uart_en` (bit 6 in control register 1) to 1 to place the MAX3301E in UART mode. D+ transfers data to DAT\_VP and SE0\_VM transfers data to D- in UART mode.

# USB On-the-Go Transceiver and Charge Pump

## General-Purpose Buffer Mode

Set `gp_en` (bit 7 in special-function register 1) and `dat_se0` (bit 2 in control register 1) to 1, set `uart_en` (bit 6 in control register 1) to zero, and drive  $\overline{OE}/\overline{INT}$  low to place the MAX3301E in general-purpose buffer mode. Control the direction of data transfer with `dminus_dir` and `dplus_dir` (bits 3 and 4 of special-function register 1, see Tables 2 and 14).

## Serial Addressing

The MAX3301E operates as a slave device that sends and receives control and status signals through an I<sup>2</sup>C-compatible 2-wire interface. The interface uses a serial data line (SDA) and a serial clock line (SCL) to achieve bidirectional communication between master(s) and slave(s). A master (typically a microcontroller) initiates all data transfers to and from the MAX3301E and generates the SCL clock that synchronizes the data transfer (Figure 13).

The MAX3301E SDA line operates as both an input and as an open-drain output. SDA requires a pullup resistor, typically 4.7k $\Omega$ . The MAX3301E SCL line only operates as an input. SCL requires a pullup resistor if there are multiple masters on the 2-wire interface, or if the master in a single-master system has an open-drain SCL output.

Each transmission consists of a start condition (see Figure 14) sent by a master device, the MAX3301E 7-bit slave address (determined by the state of ADD), plus an R/W bit (see Figure 15), a register address byte, one or more data bytes, and a stop condition (see Figure 14).

**Table 2. Setting the Direction of Data Transfer in General-Purpose Buffer Mode**

dplus_dir	dminus_dir	DIRECTION OF DATA TRANSFER
0	0	DAT_VP → D+ SE0_VM → D-
0	1	DAT_VP → D+ SE0_VM ← D-
1	0	DAT_VP ← D+ SE0_VM → D-
1	1	DAT_VP ← D+ SE0_VM ← D-

## Start and Stop Conditions

Both SCL and SDA assert high when the interface is not busy. A master device signals the beginning of a transmission with a start (S) condition by transitioning SDA from high to low while SCL is high. The master issues a stop (P) condition by transitioning SDA from low to high while SCL is high. The bus is then free for another transmission (see Figure 14).

## Bit Transfer

One data bit is transferred during each clock pulse. The data on SDA must remain stable while SCL is high (see Figure 16).

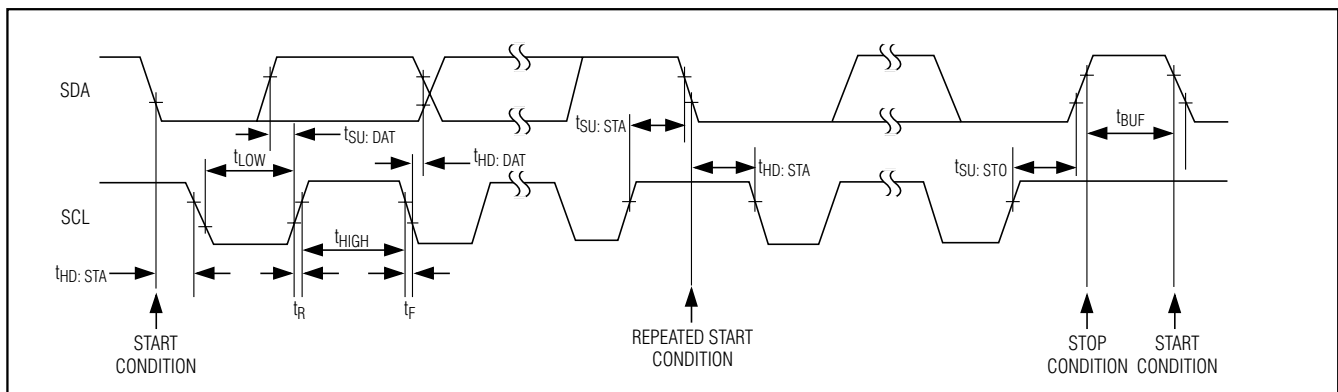

Figure 13. 2-Wire Serial Interface Timing Details



# USB On-the-Go Transceiver and Charge Pump

**MAX3301E**

**Table 3. Transmit Mode**

MODE	CONTROL PIN/BIT				INPUT		OUTPUT		DESCRIPTION	
	SUS	GP_EN	OE/INT	DAT_SE0	DAT_VP	SE0_VM	D+	D-		
	0	0	0	1	0	0	0	1	USB functional mode transceiver and I <sup>2</sup> C interface are fully functional	
	0	0	0	1	1	0	1	0		
	0	0	0	1	0	1	0	0		
	0	0	0	1	1	1	0	0		
Functional VP_VM	0	0	0	0	0	0	0	0		
	0	0	0	0	1	0	1	0		
	0	0	0	0	0	1	0	1		
	0	0	0	0	1	1	1	1		
Suspend	1	0	0	1	0	0	0	1		USB suspend mode
	1	0	0	1	1	0	1	0		
	1	0	0	1	0	1	0	0		
	1	0	0	1	1	1	0	0		
	1	0	0	0	0	0	0	0		
	1	0	0	0	1	0	1	0		
	1	0	0	0	0	1	0	1		
	1	0	0	0	1	1	1	1		
Receiving	0	0	1	X	X	X	Driver is Hi-Z	Driver is Hi-Z	See Table 4	
General-purpose buffer	X	1	0	1	See Table 2				General-purpose buffer mode	

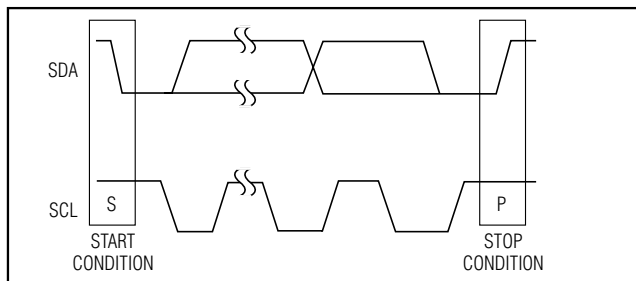

Figure 14. Start and Stop Conditions

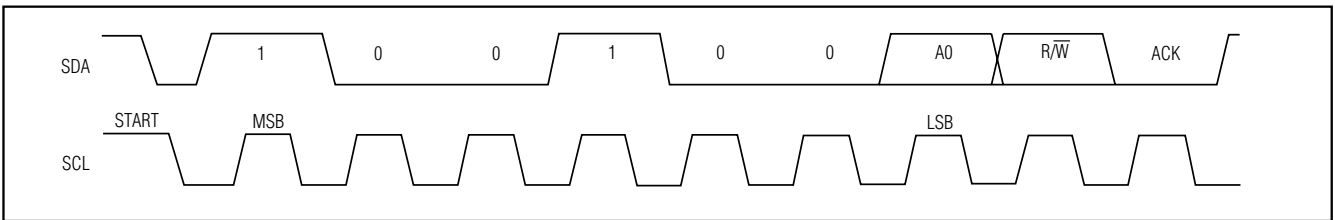

Figure 15. Slave Address

# USB On-the-Go Transceiver and Charge Pump

**MAX3301E**

**Table 4. Receive Mode**

MODE	CONTROL PIN/BIT					INPUTS		OUTPUTS				
	SUS (NOTE 7)	GP_EN	OE/INT	DAT_SE0	BI_DI	D+	D-	DAT_VP	SE0_VM	RCV	VP	VM
Functional DAT_SE0	0	0	1	1	1	0	0	Last value of DAT_VP	1	Last value of RCV	Echo D+	Echo D-
	0	0	1	1	1	1	0	1	0	1		
	0	0	1	1	1	0	1	0	0	0		
	0	0	1	1	1	1	1	Undefined	0	Undefined		
	1	0	1	1	1	0	0	0	1	0		
	1	0	1	1	1	1	0	1	0	0		
	1	0	1	1	1	0	1	0	0	0		
Functional VP_VM	0	0	1	0	1	0	0	0	0	Last value of RCV		
	0	0	1	0	1	1	0	1	0	1		
	0	0	1	0	1	0	1	0	1	0		
	0	0	1	0	1	1	1	1	1	Undefined		
	1	0	1	0	1	0	0	0	0	0		
	1	0	1	0	1	1	0	1	0	0		
	1	0	1	0	1	0	1	0	1	0		
General- purpose buffer	X	1	X	X	X	See Table 2			0			
Transmitting (see Table 3)	X	X	0	X	X	—			0			
Unidirectional (transmitter only)	X	X	X	X	0	—			0			

**Note 7:** Enter suspend mode by driving SUS high or by writing a 1 to suspend (bit 1 in control register 1), depending on the status of `spd_susp_ctl` in special-function register 1.

X = Don't care.

# USB On-the-Go Transceiver and Charge Pump

### Acknowledge

The acknowledge bit (ACK) is the 9th bit attached to any 8-bit data word. ACK is always generated by the receiving device. The MAX3301E generates an ACK when receiving an address or data by pulling SDA low during the ninth clock period. When transmitting data, the MAX3301E waits for the receiving device to generate an ACK. Monitoring ACK allows for detection of unsuccessful data transfers. An unsuccessful data transfer occurs if a receiving device is busy or if a system fault has occurred. In the event of an unsuccessful data transfer, the bus master should reattempt communication at a later time.

### Slave Address

A bus master initiates communication with a slave device by issuing a START condition followed by the 7-bit slave address (see Figure 15). When idle, the

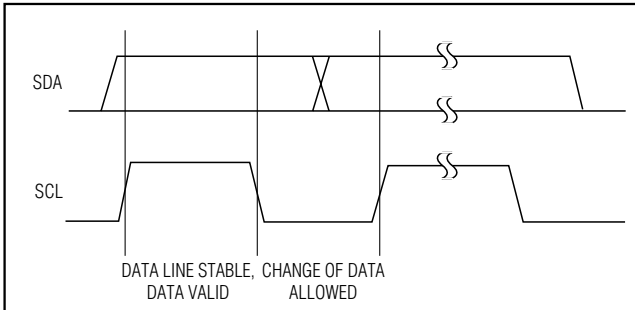

Figure 16. Bit Transfer

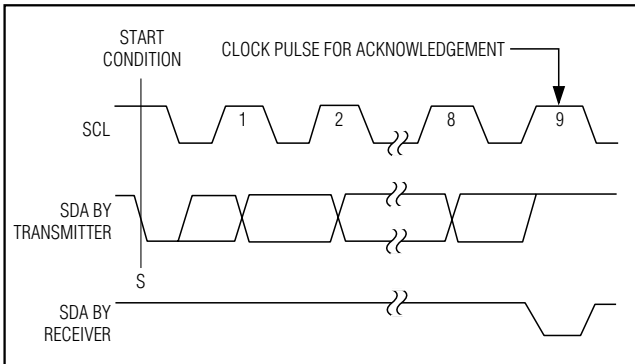

Figure 17. Acknowledge

MAX3301E waits for a START condition followed by its slave address. The LSB of the address word is the read/write (R/W) bit. R/W indicates whether the master is writing to or reading from the MAX3301E (R/W = 0 selects the write condition, R/W = 1 selects the read condition). After receiving the proper address, the MAX3301E issues an ACK.

The MAX3301E has two possible addresses (see Table 5). Address bits A6 through A1 are preset, while a reset condition or an I<sup>2</sup>C general call address loads the value of A0 from ADD. Connect ADD to GND to set A0 to 0. Connect ADD to V<sub>L</sub> to set A0 to 1. This allows up to two MAX3301Es to share the same bus.

### Write Byte Format

Writing data to the MAX3301E requires the transmission of at least 3 bytes. The first byte consists of the MAX3301E's 7-bit slave address, followed by a 0 (R/W bit). The second byte determines which register is to be written to. The third byte is the new data for the selected register. Subsequent bytes are data for sequential registers. Figure 18 shows the typical write byte format.

### Read Byte Format

Reading data from the MAX3301E requires the transmission of at least 3 bytes. The first byte consists of the MAX3301E's slave address, followed by a zero (R/W bit). The second byte selects the register from which data is read. The third byte consists of the MAX3301's slave address, followed by a one (R/W bit). The master then reads one or more bytes of data. Figure 19 shows the typical read byte format.

### Burst-Mode Write Byte Format

The MAX3301E allows a master device to write to sequential registers without repeatedly sending the slave address and register address each time. The master first sends the slave address, followed by a zero to write data to the MAX3301E. The MAX3301E sends an acknowledge bit back to the master. The master sends the 8-bit register address and the MAX3301E returns an acknowledge bit. The master writes a data byte to the selected register and receives an acknowledge bit if a supported register address has been chosen. The register address increments and is ready for

S	SLAVE ADDRESS (7 BITS)							R/W	A	REGISTER ADDRESS (8 BITS)								A	DATA (8 BITS)								A	P	
	A6	A5	A4	A3	A2	A1	A0	0		MSB								LSB	MSB								LSB		

Figure 18. Write-Byte Format

# USB On-the-Go Transceiver and Charge Pump

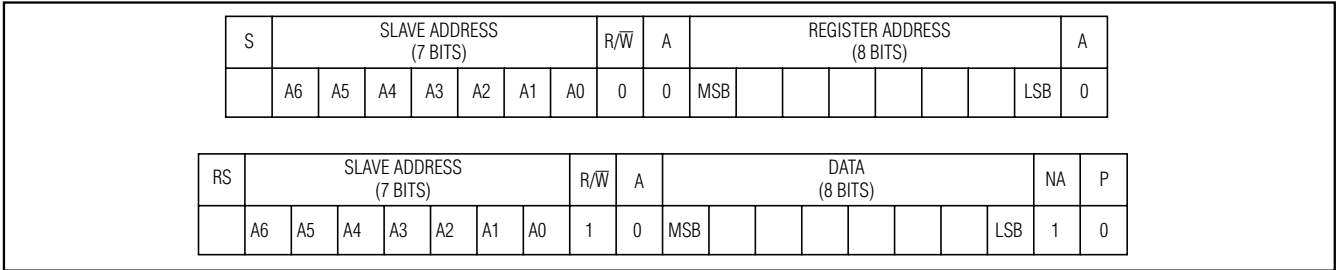

Figure 19. Read Byte Format

R/W: Read/write (R/W = 1: read; R/W = 0: write)

A: Acknowledge bit from the slave

S: Start condition

NA: Not-acknowledged bit from the master

RS: Repeated start condition

Blank: Master transmission

P: Stop condition

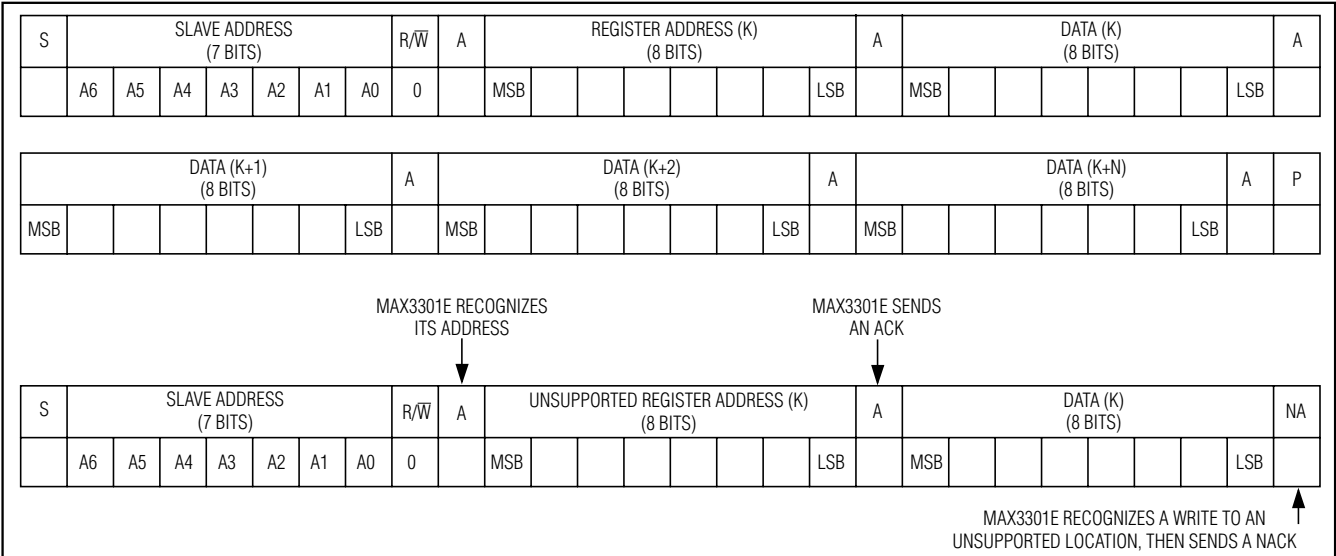

Figure 20. Burst-Mode Write Byte Format

the master to send the next data byte. The MAX3301E sends an acknowledge bit after each data byte. If an unsupported register is selected, the MAX3301E sends a NACK to the master and the register index does not increment (see Figure 20).

### Burst-Mode Read Byte Format

The MAX3301E allows a master device to read data from sequential registers with the burst-mode read byte protocol (see Figure 21). The master device first sends the slave address, followed by a zero. The MAX3301E then sends an acknowledge bit. Next, the master sends the register address to the MAX3301E, which then gen-

erates another acknowledge bit. The master then sends a stop (P) condition to the MAX3301E. Next, the master sends a start condition, followed by the MAX3301E's slave address, and then a one to indicate a read command. The MAX3301E then sends data to the master device, one byte at a time. The master sends an acknowledge bit to the MAX3301E after each data byte, and the register address of the MAX3301E increments after each byte. This continues until the master sends a stop (P) condition. If an unsupported register address is encountered, the MAX3301E sends a byte of zeros.

# USB On-the-Go Transceiver and Charge Pump

**MAX3301E**

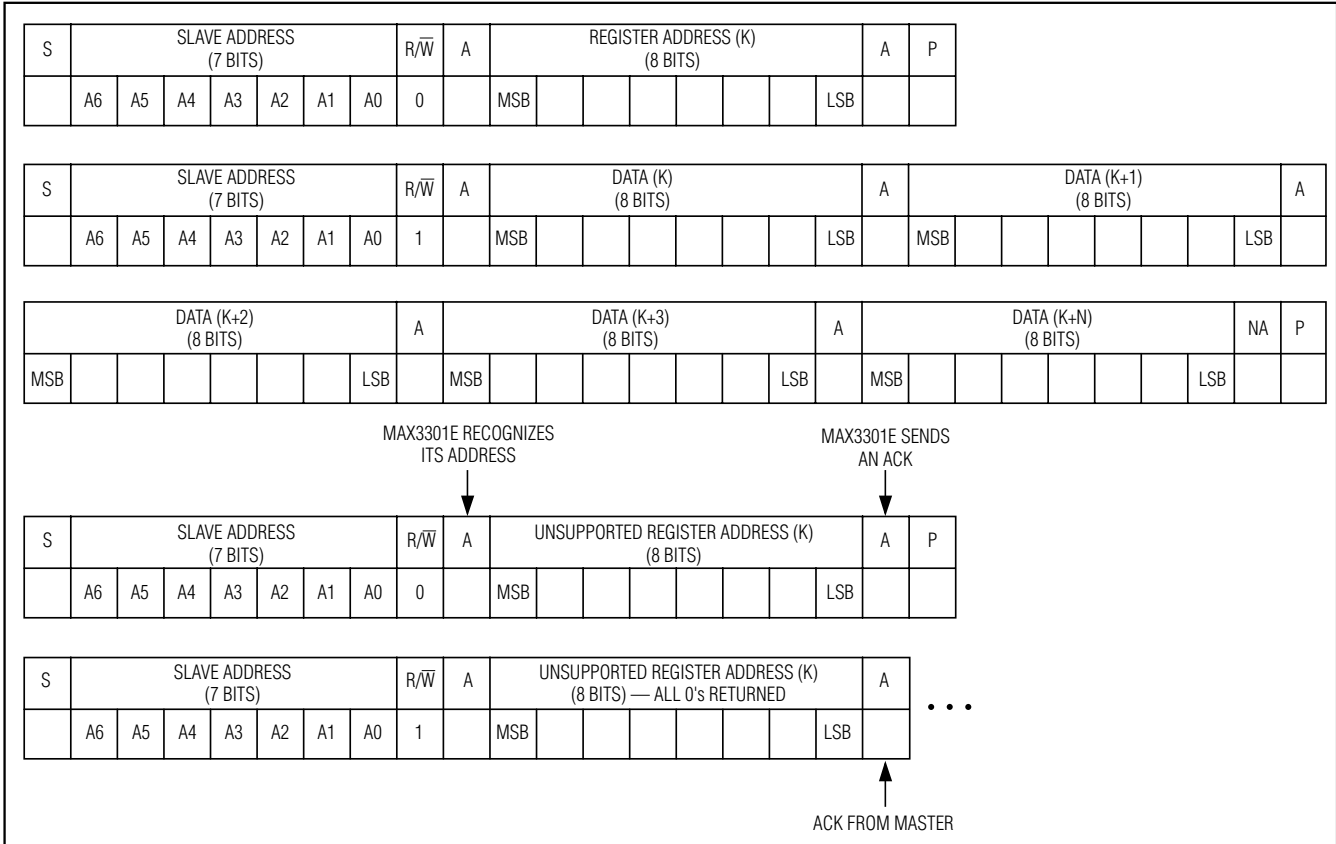

Figure 21. Burst-Mode Read Byte Format

**Table 5. I<sup>2</sup>C Slave Address Map**

ADD INPUT	ADDRESS BITS						
	A <sub>6</sub>	A <sub>5</sub>	A <sub>4</sub>	A <sub>3</sub>	A <sub>2</sub>	A <sub>1</sub>	A <sub>0</sub>
GND (0)	0	1	0	1	1	0	0
V <sub>L</sub> (1)	0	1	0	1	1	0	1

# USB On-the-Go Transceiver and Charge Pump

**MAX3301E**

**Table 6. Register Map**

REGISTER	MEMORY ADDRESS	DESCRIPTION
Vendor ID	00h, 01h	Read only. The contents of registers 00h and 01h are 6Ah and 0Bh, respectively.
Product ID	02h, 03h	Read only. The contents of registers 02h and 03h are 01h and 33h, respectively.
Control 1	04h (set) 05h (set)	Sets operating modes, maximum data rate, and direction of data transfer.
Control 2	06h (set) 07h (set)	Controls D+/D- pullup/pulldown resistor connections, ID_IN state, and V <sub>BUS</sub> behavior.
Interrupt source	08h (read)	Read only.
Unused*	09h	Not used.
Interrupt latch	0Ah (set) 0Bh (clear)	Indicates which interrupts have occurred.
Interrupt-enable Falling edge	0Ch (set) 0Dh (clear)	Enables interrupts for high-to-low transitions.
Interrupt-enable Rising edge	0Eh (set) 0Fh (clear)	Enables interrupts for low-to-high transitions.
Unused*	10h, 11h	Not used.
Special function 1	12h (set) 13h (clear)	Enables hardware/software control of the MAX3301E's is behavior, controls interrupt activity, and controls operating modes.
Revision ID	14h, 15h	Read only. The contents of registers 14h and 15h are 77h and 41h, respectively.
Special function 2	16h (set) 17h (clear)	Sets operating modes, $\overline{\text{INT}}$ output configuration, D+/D- behavior in audio mode, and TRM source.
Unused*	18h–Fh	Not used.

\*When writing to an unused register, the device generates a NACK and the register index does not increment.

## Registers

### Control Registers

There are two read/write control registers. Control register 1 (Table 7) sets operating modes, sets the data rate, and controls the direction of data transfer. Control register 2 (Table 8) connects the D+/D- pullup or pulldown resistors, sets the V<sub>BUS</sub> charge/discharge conditions, and grounds ID\_IN. The control registers have two addresses that implement write-one-set and write-one-clear features for each of these registers. Writing a one to the set address sets that bit to one. Writing a one to the clear address resets that bit to zero. Writing a zero to either address has no effect on the bits.

### Interrupt Registers

Four registers control all interrupt behavior of the MAX3301E. A source register (Table 10) indicates the current status of the various interrupt sources. An interrupt latch register (Table 11) indicates which interrupts have occurred. An interrupt-enable low and interrupt-enable high register enable interrupts on rising or falling (or both) transitions. Tables 10–13 provide the bit configurations for the various interrupt registers. The interrupt latch, interrupt-enable low, and interrupt-enable high registers have two addresses that implement write-one-set and write-one-clear features for each of these registers. Writing a one to the set address sets that bit to one. Writing a one to the clear address resets that bit to zero. Writing a zero to either address has no effect on the bits.

# USB On-the-Go Transceiver and Charge Pump

MAX3301E

**Table 7. Control Register 1 Description (Write to Address 04h to Set, Write to Address 05h to Clear)**

BIT NUMBER	SYMBOL	OPERATION	VALUE AT POWER-UP
0	speed	Set to 0 for low-speed (1.5Mbps) mode. Set to 1 for full-speed (12Mbps) mode. This bit changes the data rate only if spd_susp_ctl = 1 in special-function register 1.	0
1	suspend	Set to 0 for normal operating mode. Set to 1 for suspend mode. This bit changes the operating mode only if spd_susp_ctl = 1 in special-function register 1.	0
2	dat_se0	Set to 0 for VP_VM USB mode. Set to 1 for DAT_SE0 USB mode.	0
3	—	Not used.	0
4	bdis_acon_en	Enables the transceiver (when configured as an A device) to connect its pullup resistor if the B device disconnect is detected during HNP. Set to 0 to disable this feature. Set to 1 to enable this feature.	0
5	oe_int_en	Set to 0 to disable the interrupt output circuitry of $\overline{OE}/\overline{INT}$ . Set to 1 to enable the interrupt output circuitry of $\overline{OE}/\overline{INT}$ .	0
6	uart_en	Set to 0 to disable UART mode. Set to 1 to enable UART mode. This bit overrides the settings of dminus_dir, dplus_dir, and gp_en bits.	0
7	—	Not used.	0

**Table 8. Control Register 2 Description (Write to Address 06h to Set, Write to Address 07h to Clear)**

BIT NUMBER	SYMBOL	OPERATION	VALUE AT POWER-UP
0	dp_pullup	Set to 0 to disconnect the pullup resistor to D+. Set to 1 to connect the pullup resistor to D+.	0
1	dm_pullup	Set to 0 to disconnect the pullup resistor to D-. Set to 1 to connect the pullup resistor to D-.	0
2	dp_pulldown	Set to 0 to disconnect the pulldown resistor to D+. Set to 1 to connect the pulldown resistor to D+.	1
3	dm_pulldown	Set to 0 to disconnect the pulldown resistor to D-. Set to 1 to connect the pulldown resistor to D-.	1
4	id_pulldown	Set to 0 to allow ID_IN to float. Set to 1 to connect ID_IN to GND.	0
5	vbus_drv	Set to 0 to turn VBUS off. Set to 1 to drive VBUS through a low impedance (see Note 8).	0
6	vbus_dischrg	Set to 0 to disconnect the VBUS discharge resistor. Set to 1 to connect the VBUS discharge resistor (see Note 8).	0
7	vbus_chrg	Set to 0 to disconnect the VBUS charge resistor. Set to 1 to connect the VBUS charge resistor (see Note 8).	0

**Note 8:** To prevent a high-current state where the transceiver is both sourcing current to VBUS and sinking current from VBUS, the following logic is used to set bits 5, 6, and 7 of control register 2:

- Setting vbus\_drv clears vbus\_dischrg and vbus\_chrg
- Setting vbus\_dischrg clears vbus\_drv and vbus\_chrg, unless vbus\_drv is set with the same command, in which case vbus\_drv clears the other bits
- Setting vbus\_chrg clears vbus\_drv and vbus\_dischrg, unless either of these bits are set with the same command, as shown in Table 9

# USB On-the-Go Transceiver and Charge Pump

**Table 9. VBUS Control Logic**

SET COMMAND (ADDRESS 06h)			BEHAVIOR OF MAX3301E		
vbus_drv	vbus_dischrg	vbus_chrg	vbus_drv	vbus_dischrg	vbus_chrg
1	X	X	1	0	0
0	1	X	0	1	0
0	0	1	0	0	1
0	0	0	Not affected	Not affected	Not affected

**Table 10. Interrupt Source Register (Address 08h is Read Only)**

BIT NUMBER	SYMBOL	CONTENTS
0	vbus_vld	Logic 1 if VBUS > VBUS valid comparator threshold.
1	sess_vld	Logic 1 if VBUS > session valid comparator threshold.
2	dp_hi	Logic 1 if VD+ > dp_hi comparator threshold (D+ assertion during data line pulsing through SRP method).
3	id_gnd	Logic 1 if VID_IN < 0.1 x VCC.
4	dm_hi	Logic 1 if VD- > dm_hi comparator threshold (D- assertion during data line pulsing through SRP method).
5	id_float	Logic 1 if VID_IN > 0.9 x VCC.
6	bdis_acon	Logic 1 if bdis_acon_en = 1 and the MAX3301E asserts dp_pullup after detecting a B device disconnect during HNP.
7	cr_int_sess_end	Logic 1 if VBUS < sess_end comparator threshold, or if VD+ > cr_int comparator threshold (0.4V to 0.6V), depending on the value of int_source (bit 5 of special-function register 1, see Table 14).

**Table 11. Interrupt Latch Register Description (Write to Address 0Ah to Set, Write to Address 0Bh to Clear)**

BIT NUMBER	SYMBOL	CONTENTS	VALUE AT POWER-UP
0	vbus_vld	vbus_vld asserts if a transition occurs on this condition and the appropriate interrupt-high or interrupt-low enable bit is set. See Tables 10, 12, and 13.	0
1	sess_vld	sess_vld asserts if a transition occurs on this condition and the appropriate interrupt-high or interrupt-low enable bit is set. See Tables 10, 12, and 13.	0
2	dp_hi	dp_hi asserts if a transition occurs on this condition and the appropriate interrupt-high or interrupt-low enable bit is set. See Tables 10, 12, and 13.	0
3	id_gnd	id_gnd asserts if a transition occurs on this condition and the appropriate interrupt-high or interrupt-low enable bit is set. See Tables 10, 12, and 13.	0
4	dm_hi	dm_hi asserts if a transition occurs on this condition and the appropriate interrupt-high or interrupt-low enable bit is set. See Tables 10, 12, and 13.	0
5	id_float	id_float asserts if a transition occurs on this condition and the appropriate interrupt-high or interrupt-low enable bit is set. See Tables 10, 12, and 13.	0
6	bdis_acon	bdis_acon asserts if a transition occurs on this condition and the appropriate interrupt-high or interrupt-low enable bit is set. See Tables 10, 12, and 13.	0
7	cr_int_sess_end	cr_int_sess_end asserts if a transition occurs on this condition and the appropriate interrupt-high or interrupt-low enable bit is set. See Tables 10, 12, and 13.	0



# USB On-the-Go Transceiver and Charge Pump

**MAX3301E**

**Table 12. Interrupt-Enable Low Register (Write to Address 0Ch to Set, Write to Address 0Dh to Clear)**

BIT NUMBER	SYMBOL	CONTENTS	VALUE AT POWER-UP
0	vbus_vld	Set to 0 to disable the vbus_vld interrupt for a high-to-low transition. Set to 1 to enable the vbus_vld interrupt for a high-to-low transition. See Tables 10 and 11.	0
1	sess_vld	Set to 0 to disable the sess_vld interrupt for a high-to-low transition. Set to 1 to enable the sess_vld interrupt for a high-to-low transition. See Tables 10 and 11.	0
2	dp_hi	Set to 0 to disable the dp_hi interrupt for a high-to-low transition. Set to 1 to enable the dp_hi interrupt for a high-to-low transition. See Tables 10 and 11.	0
3	id_gnd	Set to 0 to disable the id_gnd interrupt for a high-to-low transition. Set to 1 to enable the id_gnd interrupt for a high-to-low transition. See Tables 10 and 11.	0
4	dm_hi	Set to 0 to disable the dm_hi interrupt for a high-to-low transition. Set to 1 to enable the dm_hi interrupt for a high-to-low transition. See Tables 10 and 11.	0
5	id_float	Set to 0 to disable the id_float interrupt for a high-to-low transition. Set to 1 to enable the id_float interrupt for a high-to-low transition. See Tables 10 and 11.	0
6	bdis_acon	Set to 0 to disable the bdis_acon interrupt for a high-to-low transition. Set to 1 to enable the bdis_acon interrupt for a high-to-low transition. See Tables 10 and 11.	0
7	cr_int_sess_end	Set to 0 to disable the cr_int_sess_end interrupt for a high-to-low transition. Set to 1 to enable the cr_int_sess_end interrupt for a high-to-low transition. See Tables 10 and 11.	0

**Table 13. Interrupt-Enable High Register (Write to Address 0Eh to Set, Write to Address 0Fh to Clear)**

BIT NUMBER	SYMBOL	CONTENTS	VALUE AT POWER-UP
0	vbus_vld	Set to 0 to disable the vbus_vld interrupt for a low-to-high transition. Set to 1 to enable the vbus_vld interrupt for a low-to-high transition. See Tables 10 and 11.	0
1	sess_vld	Set to 0 to disable the sess_vld interrupt for a low-to-high transition. Set to 1 to enable the sess_vld interrupt for a low-to-high transition. See Tables 10 and 11.	0
2	dp_hi	Set to 0 to disable the dp_hi interrupt for a low-to-high transition. Set to 1 to enable the dp_hi interrupt for a low-to-high transition. See Tables 10 and 11.	0
3	id_gnd	Set to 0 to disable the id_gnd interrupt for a low-to-high transition. Set to 1 to enable the id_gnd interrupt for a low-to-high transition. See Tables 10 and 11.	0
4	dm_hi	Set to 0 to disable the dm_hi interrupt for a low-to-high transition. Set to 1 to enable the dm_hi interrupt for a low-to-high transition. See Tables 10 and 11.	0
5	id_float	Set to 0 to disable the id_float interrupt for a low-to-high transition. Set to 1 to enable the id_float interrupt for a low-to-high transition. See Tables 10 and 11.	0
6	bdis_acon	Set to 0 to disable the bdis_acon interrupt for a low-to-high transition. Set to 1 to enable the bdis_acon interrupt for a low-to-high transition. See Tables 10 and 11.	0
7	cr_int_sess_end	Set to 0 to disable the cr_int_sess_end interrupt for a low-to-high transition. Set to 1 to enable the cr_int_sess_end interrupt for a low-to-high transition. See Tables 10 and 11.	0

# USB On-the-Go Transceiver and Charge Pump

## Special-Function Registers

Tables 14 and 15 describe the special-function registers. Special-function register 1 determines whether hardware or software controls the maximum data rate and suspend behavior, sets the direction of data transfer, and toggles general-purpose buffer mode. Special-function register 2 enables shutdown mode, configures the interrupt output as open-drain or push-pull, sets the

TRM power source, and controls the D+/D- connections for audio mode. The special-function registers have two addresses that implement write-one-set and write-one-clear features for each of these registers. Writing a one to the set address sets that bit to one. Writing a one to the clear address resets that bit to zero. Writing a zero to either address has no effect on the bits.

**Table 14. Special-Function Register 1 (Write to Address 12h to Set, Write to Address 13h to Clear)**

BIT NUMBER	SYMBOL	CONTENTS	VALUE AT POWER-UP
0	int_sdwn	Set to 0 for normal operation. Set to 1 to enter interrupt shutdown mode. The I <sup>2</sup> C interface and interrupt sources remain active, while all other circuitry is off.	0
1	spd_susp_ctl	Set to 0 to control the MAX3301E behavior with SPD and SUS. Set to 1 to control the MAX3301E behavior with the speed and suspend bits in control register 1 (see Table 7).	0
2	bi_di	Set to 0 to transfer data from DAT_VP and SE0_VM to D+ and D-, respectively. DAT_VP and SE0_VM are always inputs when this bit is 0. Set to 1 to control the direction of data transfer with $\overline{OE}/\overline{INT}$ .	1
3	dminus_dir	Set to 0 to transfer data from SE0_VM to D-. Set to 1 to transfer data from D- to SE0_VM. Ensure that gp_en = 1, dat_se0 = 1, uart_en = 0, and $\overline{OE}/\overline{INT}$ = low to activate this function.	0
4	dplus_dir	Set to 0 to transfer data from DAT_VP to D+. Set to 1 to transfer data from D+ to DAT_VP. Ensure that gp_en = 1, dat_se0 = 1, uart_en = 0, and $\overline{OE}/\overline{INT}$ = low to activate this function.	0
5	int_source	Set to 0 to use cr_int as the interrupt source for bit 7 of the interrupt source register. Set to 1 to use sess_end as the interrupt source for bit 7 of the interrupt source register (see Table 10).	0
6	sess_end	Session end comparator status (read only). Sess_end = 0 when V <sub>BUS</sub> > sess_end threshold. Sess_end = 1 when V <sub>BUS</sub> < sess_end threshold.	
7	gp_en	Set to 0 to disable general-purpose buffer mode. Set to 1 to enable general-purpose buffer mode.	0

**Table 15. Special-Function Register 2 (Write to Address 16h to Set, Write to Address 17h to Clear)**

BIT NUMBER	SYMBOL	CONTENTS	VALUE AT POWER-UP
0	sdwn	Set to 0 for normal operation. Set to 1 to enable shutdown mode. Only the I <sup>2</sup> C interface remains active in shutdown.	1
1	irq_mode	Set to 0 to set $\overline{INT}$ and $\overline{OE}/\overline{INT}$ as open-drain outputs. Set to 1 to set $\overline{INT}$ and $\overline{OE}/\overline{INT}$ as push-pull outputs.	0
2	xcvr_input_disc	Set to 0 to leave the D+/D- single-ended receiver inputs connected. Set to 1 to disconnect the D+/D- receiver inputs to reduce power consumption in audio mode.	0
3	reg_sel	Set to 0 to power TRM from V <sub>CC</sub> . Set to 1 to power TRM from V <sub>BUS</sub> .	0
4, 5, 6, 7	—	Reserved. Set to 0 for normal operation.	0000

# USB On-the-Go Transceiver and Charge Pump

### ID and Manufacturer Register Address Map

Table 16 provides the contents of the ID registers of the MAX3301E. Addresses 00h and 01h comprise the vendor ID registers. Addresses 02h and 03h comprise the product ID registers. Addresses 14h and 15h comprise the revision ID registers.

**Table 16. ID Registers**

REGISTER	ADDRESS	CONTENTS
Vendor ID	00h	6Ah
	01h	0Bh
Product ID	02h	01h
	03h	33h
Revision ID	14h	77h
	15h	41h

### Audio Car Kit

Many cell phones are required to interface to car kits. Depending upon the car kit, the interface to the phone may be required to support any or all of the following functions:

- Audio input
- Audio output
- Charging
- Control and status

The MAX3301E allows support of the CEA-936A car kit interface standard.

### External Components

#### External Resistors

Two external resistors ( $27.4\Omega \pm 1\%$ ) are required for USB connection. Install one resistor in series between D+ of the MAX3301E and D+ of the USB connector. Install the other resistor in series between D- of the MAX3301E and D- of the USB connector (see the *Typical Operating Circuit*).

#### External Capacitors

Five external capacitors are recommended for proper operation. Install all capacitors as close to the device as possible. Decouple  $V_L$  to GND with a  $0.1\mu\text{F}$  ceramic capacitor. Bypass  $V_{CC}$  to GND with a  $1\mu\text{F}$  ceramic capacitor. Bypass TRM to GND with a  $1\mu\text{F}$  (or greater) ceramic or plastic capacitor. Connect a  $100\text{nF}$  flying capacitor between C+ and C- for the charge pump (see the *Typical Operating Circuit*). Bypass  $V_{BUS}$  to GND

with a  $1\mu\text{F}$  to  $6.5\mu\text{F}$  ceramic capacitor in accordance with USB OTG specifications.

### ESD Protection

To protect the MAX3301E against ESD, D+, D-, ID\_IN, and  $V_{BUS}$  have extra protection against static electricity to protect the device up to  $\pm 15\text{kV}$ . The ESD structures withstand high ESD in all states; normal operation, suspend mode, interrupt shutdown, and shutdown. For the ESD structures to work correctly, connect a  $1\mu\text{F}$  or greater capacitor from TRM to GND and from  $V_{BUS}$  to GND. ESD protection can be tested in various ways; the D+, D-, ID\_IN, and  $V_{BUS}$  inputs/outputs are characterized for protection to the following limits:

- $\pm 15\text{kV}$  using the Human Body Model
- $\pm 6\text{kV}$  using the IEC 61000-4-2 Contact Discharge Method
- $\pm 10\text{kV}$  using the IEC 61000-4-2 Air-Gap Discharge Method

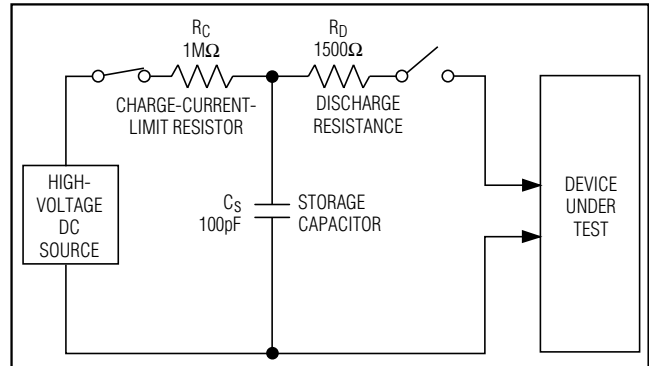

Figure 22. Human Body ESD Test Modes

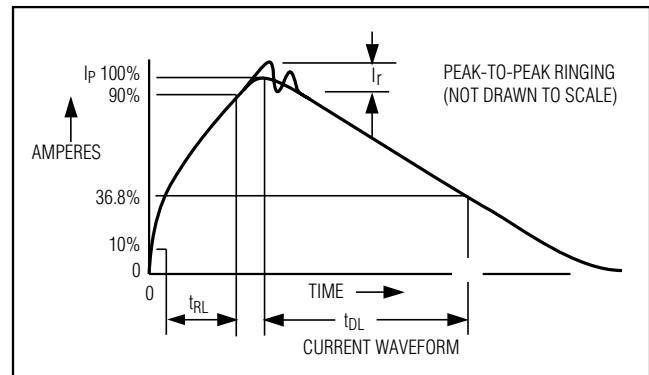

Figure 23. Human Body Model Current Waveform

# USB On-the-Go Transceiver and Charge Pump

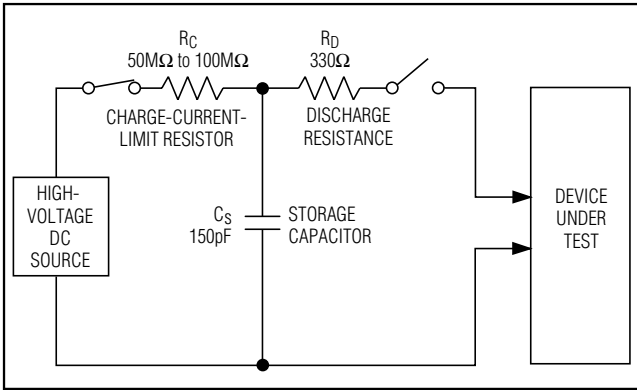

Figure 24. IEC 61000-4-2 ESD Test Model

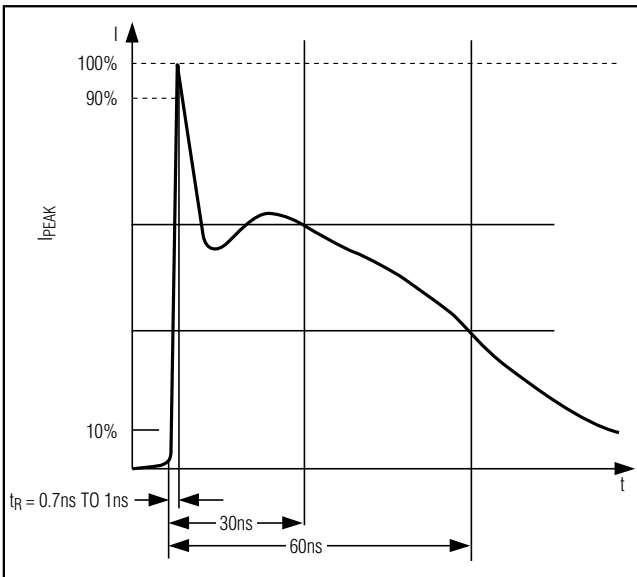

Figure 25. IEC 61000-4-2 Current Waveform

ESD performance depends on a variety of conditions. Contact Maxim for a reliability report that documents test setup, test methodology, and test results.

### Human Body Model

Figure 22 shows the Human Body Model and Figure 23 shows the current waveform it generates when discharged into a low impedance. This model consists of a 100pF capacitor charged to the ESD voltage of interest, which is then discharged into the test device through a 1.5kΩ resistor.

### IEC 61000-4-2

The IEC 61000-4-2 standard covers ESD testing and performance of finished equipment; it does not specifically refer to integrated circuits. The MAX3301E helps the user design equipment that meets level 3 of IEC 61000-4-2, without the need for additional ESD-protection components. The major difference between tests done using the Human Body Model and IEC 1000-4-2 is a higher peak current in IEC 61000-4-2, due to the fact that series resistance is lower in the IEC 61000-4-2 model. Hence, the ESD-withstand voltage measured to IEC 61000-4-2 is generally lower than that measured using the Human Body Model. Figure 24 shows the IEC 61000-4-2 model. The Air-Gap Discharge test involves approaching the device with a charged probe. The contact discharge method connects the probe to the device before the probe is energized. Figure 25 shows the IEC 61000-4-2 current waveform.

### Layout Considerations

The MAX3301E high operating frequency makes proper layout important to ensure stability and maintain the output voltage under all loads. For best performance, minimize the distance between the bypass capacitors and the MAX3301E. Use symmetric trace geometry from D+ and D- to the USB connector.

### UCSP Applications Information

For the latest application details on UCSP construction, dimensions, tape carrier information, PC board techniques, bump-pad layout, and the recommended reflow temperature profile, as well as the latest information on reliability testing results, refer to the Application Note: *UCSP—A Wafer-Level Chip-Scale Package* available on Maxim's website at [www.maxim-ic.com/ucsp](http://www.maxim-ic.com/ucsp).

### Chip Information

TRANSISTOR COUNT: 10,004

PROCESS: BiCMOS

# USB On-the-Go Transceiver and Charge Pump

## Pin Configurations

**MAX3301E**

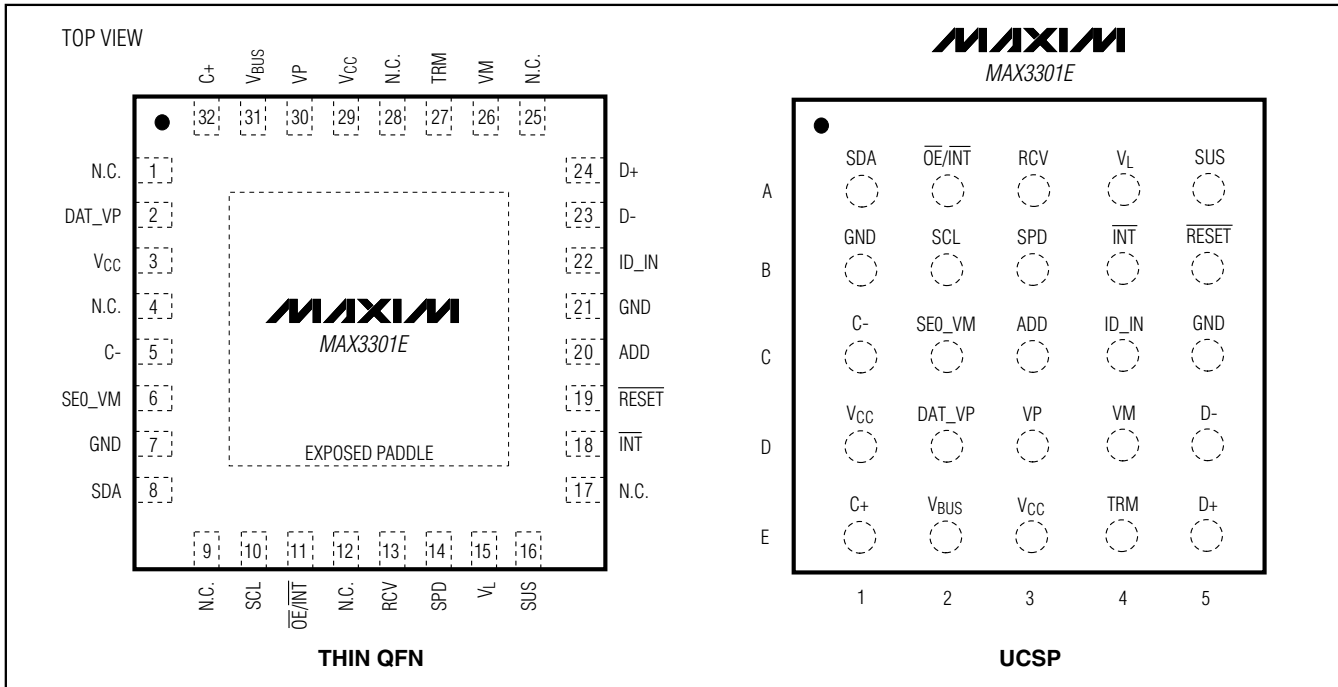

# USB On-the-Go Transceiver and Charge Pump

**MAX3301E**

## Typical Operating Circuit

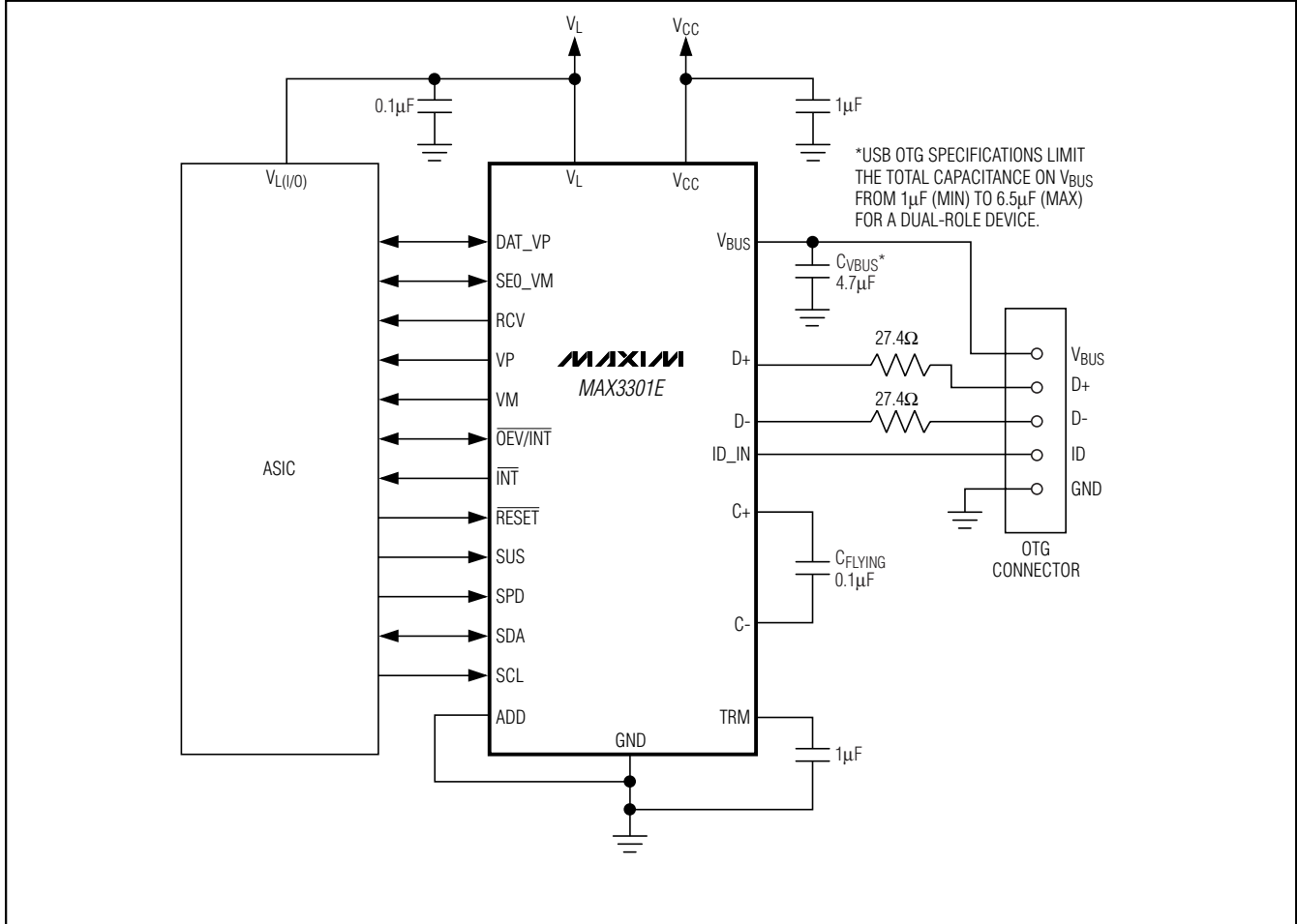

# USB On-the-Go Transceiver and Charge Pump

## Package Information

(The package drawing(s) in this data sheet may not reflect the most current specifications. For the latest package outline information, go to [www.maxim-ic.com/packages](http://www.maxim-ic.com/packages).)

**MAX3301E**

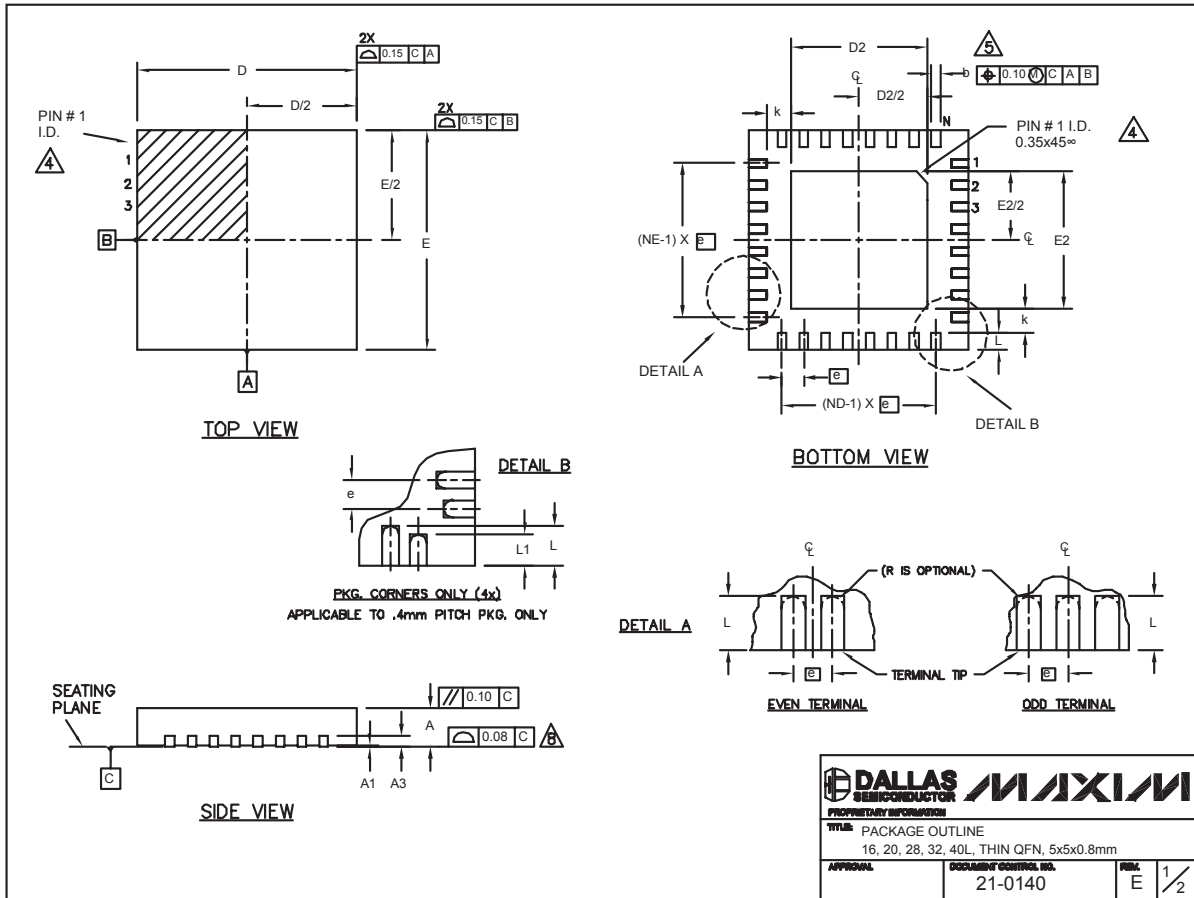

# USB On-the-Go Transceiver and Charge Pump

## Package Information (continued)

(The package drawing(s) in this data sheet may not reflect the most current specifications. For the latest package outline information, go to [www.maxim-ic.com/packages](http://www.maxim-ic.com/packages).)

COMMON DIMENSIONS															
PKG.	16L 5x5			20L 5x5			28L 5x5			32L 5x5			40L 5x5		
SYMBOL	MIN.	NOM.	MAX.	MIN.	NOM.	MAX.	MIN.	NOM.	MAX.	MIN.	NOM.	MAX.	MIN.	NOM.	MAX.
A	0.70	0.75	0.80	0.70	0.75	0.80	0.70	0.75	0.80	0.70	0.75	0.80	0.70	0.75	0.80
A1	0	0.02	0.05	0	0.02	0.05	0	0.02	0.05	0	0.02	0.05	0	-	0.05
A3	0.20 REF.			0.20 REF.			0.20 REF.			0.20 REF.			0.20 REF.		
b	0.25	0.30	0.35	0.25	0.30	0.35	0.20	0.25	0.30	0.20	0.25	0.30	0.15	0.20	0.25
D	4.90	5.00	5.10	4.90	5.00	5.10	4.90	5.00	5.10	4.90	5.00	5.10	4.90	5.00	5.10
E	4.90	5.00	5.10	4.90	5.00	5.10	4.90	5.00	5.10	4.90	5.00	5.10	4.90	5.00	5.10
e	0.80 BSC.			0.65 BSC.			0.50 BSC.			0.50 BSC.			0.40 BSC.		
k	0.25	-	-	0.25	-	-	0.25	-	-	0.25	-	-	0.25	0.35	0.45
L	0.30	0.40	0.50	0.45	0.55	0.65	0.45	0.55	0.65	0.30	0.40	0.50	0.40	0.50	0.60
L1	-	-	-	-	-	-	-	-	-	-	-	-	0.30	0.40	0.50
N	16			20			28			32			40		
ND	4			5			7			8			10		
NE	4			5			7			8			10		
JEDEC	WHHB			WHHC			WHHD-1			WHHD-2			-		

EXPOSED PAD VARIATIONS									
PKG. CODES	D2			E2			DOWN BONDS ALLOWED		
	MIN.	NOM.	MAX.	MIN.	NOM.	MAX.			
T1655-1	3.00	3.10	3.20	3.00	3.10	3.20	NO		
T1655-2	3.00	3.10	3.20	3.00	3.10	3.20	YES		
T2055-2	3.00	3.10	3.20	3.00	3.10	3.20	NO		
T2055-3	3.00	3.10	3.20	3.00	3.10	3.20	YES		
T2055-4	3.00	3.10	3.20	3.00	3.10	3.20	NO		
T2855-1	3.15	3.25	3.35	3.15	3.25	3.35	NO		
T2855-2	2.60	2.70	2.80	2.60	2.70	2.80	NO		
T2855-3	3.15	3.25	3.35	3.15	3.25	3.35	YES		
T2855-4	2.60	2.70	2.80	2.60	2.70	2.80	YES		
T2855-5	2.60	2.70	2.80	2.60	2.70	2.80	NO		
T2855-6	3.15	3.25	3.35	3.15	3.25	3.35	NO		
T2855-7	2.60	2.70	2.80	2.60	2.70	2.80	YES		
T3255-2	3.00	3.10	3.20	3.00	3.10	3.20	NO		
T3255-3	3.00	3.10	3.20	3.00	3.10	3.20	YES		
T3255-4	3.00	3.10	3.20	3.00	3.10	3.20	NO		
T4055-1	3.20	3.30	3.40	3.20	3.30	3.40	YES		

NOTES:

- DIMENSIONING & TOLERANCING CONFORM TO ASME Y14.5M-1994.
- ALL DIMENSIONS ARE IN MILLIMETERS. ANGLES ARE IN DEGREES.
- N IS THE TOTAL NUMBER OF TERMINALS.
- THE TERMINAL #1 IDENTIFIER AND TERMINAL NUMBERING CONVENTION SHALL CONFORM TO JESD 95-1 SPP-012. DETAILS OF TERMINAL #1 IDENTIFIER ARE OPTIONAL, BUT MUST BE LOCATED WITHIN THE ZONE INDICATED. THE TERMINAL #1 IDENTIFIER MAY BE EITHER A MOLD OR MARKED FEATURE.
- DIMENSION b APPLIES TO METALLIZED TERMINAL AND IS MEASURED BETWEEN 0.25 mm AND 0.30 mm FROM TERMINAL TIP.
- ND AND NE REFER TO THE NUMBER OF TERMINALS ON EACH D AND E SIDE RESPECTIVELY.
- DEPOPULATION IS POSSIBLE IN A SYMMETRICAL FASHION.
- COPLANARITY APPLIES TO THE EXPOSED HEAT SINK SLUG AS WELL AS THE TERMINALS.
- DRAWING CONFORMS TO JEDEC MO220, EXCEPT EXPOSED PAD DIMENSION FOR T2855-1, T2855-3 AND T2855-6.
- WARPAGE SHALL NOT EXCEED 0.10 mm.

<b>PROPRIETARY INFORMATION</b>	
<b>TITLE:</b> PACKAGE OUTLINE 16, 20, 28, 32, 40L, THIN QFN, 5x5x0.8mm	
<b>APPROVAL:</b>	<b>DOCUMENT CONTROL NO.</b> 21-0140
<b>FILE:</b> E	2/2



# USB On-the-Go Transceiver and Charge Pump

## Package Information (continued)

(The package drawing(s) in this data sheet may not reflect the most current specifications. For the latest package outline information, go to [www.maxim-ic.com/packages](http://www.maxim-ic.com/packages).)

**MAX3301E**

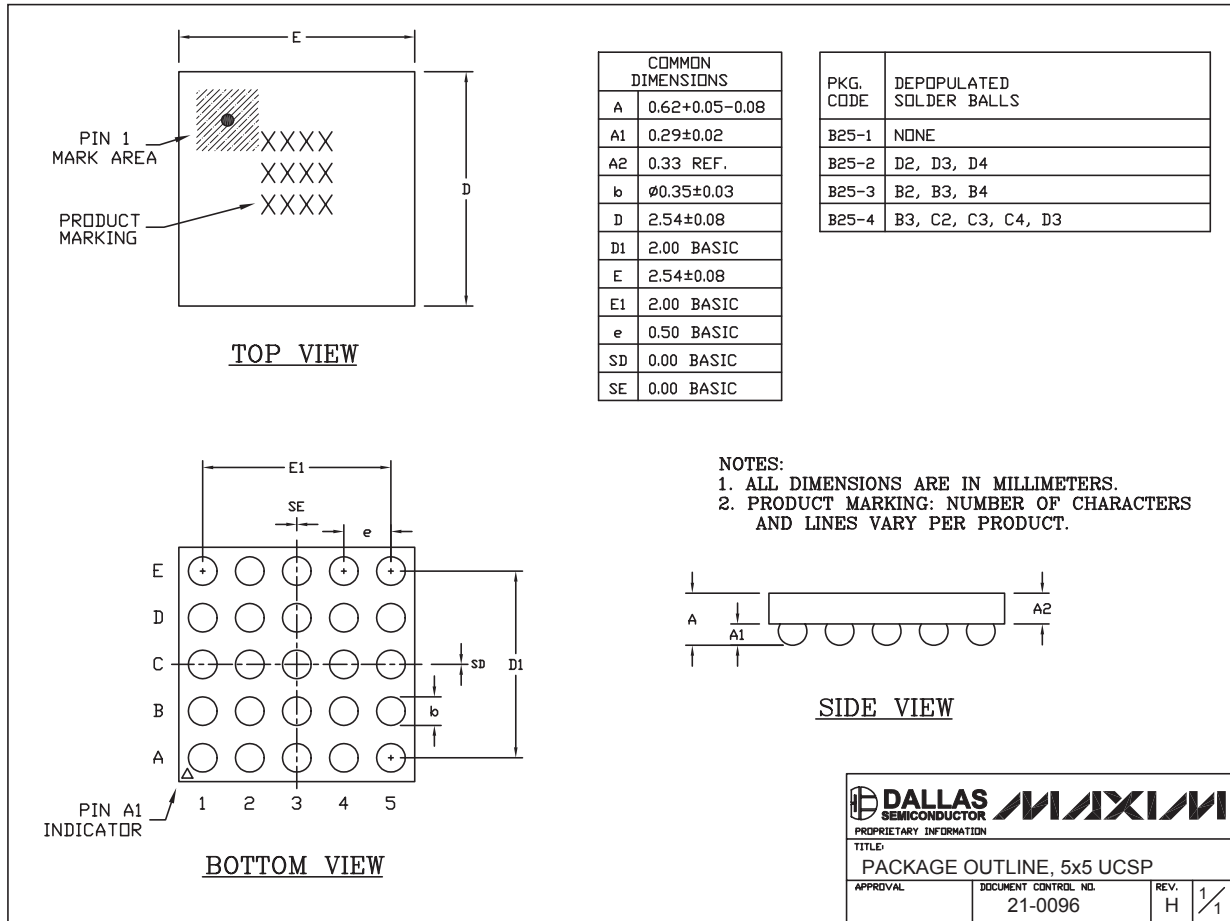

25L UCSP.EPS

Maxim cannot assume responsibility for use of any circuitry other than circuitry entirely embodied in a Maxim product. No circuit patent licenses are implied. Maxim reserves the right to change the circuitry and specifications without notice at any time.

**Maxim Integrated Products, 120 San Gabriel Drive, Sunnyvale, CA 94086 408-737-7600** \_\_\_\_\_ **33**